

XTRAVELLER

HYBRID CAMPER TRAILER

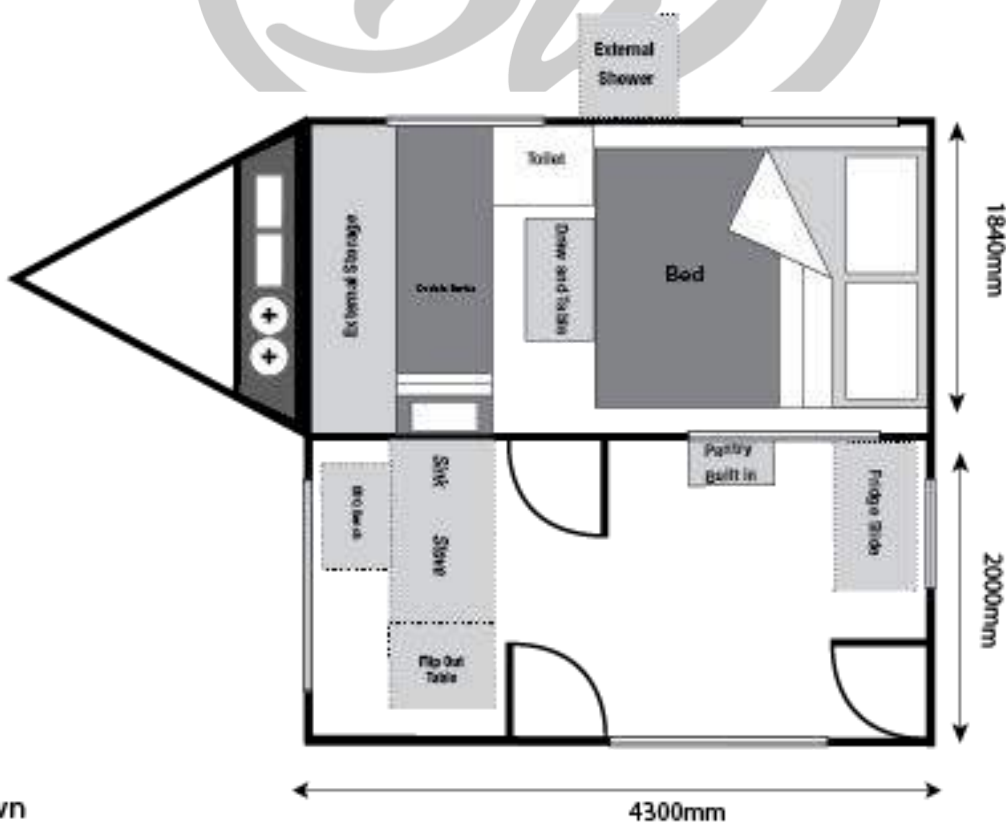

BLUE WATER
CAMPERS *Discover Australia*



2022 Model Shown

Read Owner's Manual before using the equipment. Third Party Component Manuals should be read in conjunction with this manual. Maintenance guidelines must be met or exceeded, failing to meet these guidelines may result in serious injury or death and property damage.

bluwatercampers.com.au ☎ 1300 594 000

Table of Contents

<i>Introduction</i>	4	Securing Your Camper	14
<i>Camper Safety Bulletin</i>	5	<i>Maintenance</i>	15
<i>Anderson Plug</i>	5	Maintenance Schedule	16
<i>Camper structure</i>	5	Torque Settings	23
<i>Break-away Controller</i>	5	Wheel Nuts	23
<i>Brake Controller</i>	5	Hitch	23
<i>Canvas</i>	5	Trailing Arm Pivot Bolts	23
<i>Insurance</i>	5	<i>Brakes and Handbrake - Electric</i>	23
<i>Safety chains</i>	5	Features	23
<i>Storage and travel</i>	5	Operation	23
<i>Tyres</i>	5	Breakaway Switch	24
<i>Trailer training course</i>	5	Trailer Plug Wiring	24
<i>Wheel Bearings</i>	5	Hand Brake	25
<i>Wheel Nuts</i>	5	Hand Brake Adjuster	25
<i>About yourcamper</i>	6	Correct Use of Your Electric Brakes	26
Bearings and Seals	6	Important Safety Notice	26
Fridge Fitting Chart	7	Brake Adjustment	26
Hitch	7	Brake Cleaning and Inspection	26
<i>Canvas Annex Care</i>	8	Magnets	27
Seasoning the Canvas	8	Shoes and Linings	27
Protecting Seams and Screens	8	Corrosion Prevention	27
Zipper Care	8	<i>Wheels and Tyres</i>	28
Protecting from Mould & Moisture	8	Highway	28
<i>Setting up your Camper</i>	10	Off Road	28
Loading Your Caravan	10	<i>Suspension</i>	28
Choosing a Spot to Set Up	10	Shock Absorbers & Bushes	28
Levelling Your Camper	11	Jacking Your Camper	28
Site Power	11	<i>Electrical Systems</i>	29
Pole Diagram	12	Chargers & Inverters	29
Preparing for Bad Weather	13	Battery Care	29
Packing Away Your Camper	13	BSLBATT Lithium Battery Bluetooth App	29
<i>Storage & Care</i>	13	Solar Panel	34
Long Term Storage	13	12 Volt Wiring Diagram	34
Interior	13	Control Panel	35
Exterior	13	Water Pump	35
<i>Batteries</i>	14	Mains Water	35
Care of Paint and Surfaces	14	Connecting the Gas	35
Shade and screen care	14	Kitchen	35
		<i>Pre-Trip Checklist</i>	36
		<i>Useful Accessories</i>	36
		Levelling Blocks	36
		Wheel Chocks	37
		Covers	37
		Stone Protection	37

<i>Trouble Shooting</i>	38
Electrical	38
Water	39
Gas	39
Brakes.....	40
<i>Handy Tips</i>	41
Driving Off Road	41
Trip Planning.....	42
<i>Warranty Statement</i>	43
<i>Supplier Contact Details</i>	47



Introduction



WARNING– Before using this product you should read this manual and those manuals supplied by component manufacturers applicable to this product.

This manual is supplied as a reference to required maintenance of the product. Failure to use and maintain the product in accordance with what is outlined in this manual may affect your warranty.

Incorrect and/or insufficient maintenance may cause product failure resulting in property loss, damage or injury or death. Maintenance intervals are guidance for normal use, extreme use may require shorter or additional maintenance intervals.

Manual content does not imply, express or over rule any other warranty, the owner should read the limited warranty terms included in this booklet.

Before using this product, you should be certain your tow vehicle is suitably rated and equipped to tow the product safely and legally. The trailer and vehicle pairing must be within the safe **“Maximum Towing Capacity”**, **“Ball Weight Capacity”** and **“Gross Combination Mass”** as stated by the vehicle manufacturer.

Store Locations

QUEENSLAND	Ph 07 3333 1952
Gold Coast 9 Indy Court Carrara, QLD 4211	
NEW SOUTH WALES	Ph 02 4474 4410
South Coast 39-41 Shelley Road Moruya, NSW 2537	
VICTORIA	Ph 03 5945 5344
Melbourne 31 Commercial Drive Pakenham, VIC 3810	
Albury/Wodonga 4 Kane Road Wodonga, VIC 3690	Ph 0484 618 549
WESTERN AUSTRALIA	Ph 08 6244 2077
Perth 46 Stebbing Road Maddington, WA 6109	
SOUTH AUSTRALIA	Ph 08 8522 1141
Adelaide U3/27 Theen Ave, Willaston, SA 5118	
NATIONAL	1300 594 000

Camper Safety Bulletin

Safety and Maintenance Recommendations for Camper Trailers & Hybrids

Anderson Plug

In a camper, where they have either a battery that requires charging or a fridge that operates off a 12V supply, an Anderson Plug is essential. Ensure you have the correct power rated Anderson plug for your camper trailer.

Camper structure

Do not drill into or penetrate the chassis, body, walls, roof, or lid of the camper, this may void the warranty.

Break-away Controller

The break-away controller is fitted to the camper trailer. The cable needs to be secured to the tow vehicle to ensure the controller functions correctly if the two vehicle and trailer are separated. This needs to be attached independently to the tow vehicle and not to the shackle which secures the trailer chains to the car.

Brake Controller

Fit a brake controller to your car to ensure the effective braking of the camper trailer.

Canvas

Make sure the camper tent, annex or awning is thoroughly dry before storage. Under certain conditions the canvas will sweat and grow mold, this is not covered by warranty. Always make sure the canvas is clean and dry. Remove all bird droppings, sticks, stones or other debris before the tent or annex is packed for storage. Protect the canvas from damage and sharp implements or poles penetrating the canvas. Keep any flame or hot implement away from canvas.

Insurance

Remember to have your camper insured with the correct type of coverage for your intended journey. This should include recovery and additional costs in the case of breakdown or accident which disables the camper. The trailer is generally not covered by your tow vehicle's insurance.

Safety chains

Safety Chains are attached between the drawbar and the towbar for the purpose of retaining connection between the towing vehicle and the trailer in the event of coupling failure. Cross over the chains onto the towing hitch. The caravan industry recommendation is that a shackle meeting the requirements of AS 2741-2002 be used to secure rated safety chains up to 3500kg capacity.

Storage and travel

Ensure all gas bottles are turned off and 12-volt master switch is turned off. Do not travel above 100km/h on sealed roads, travel at an appropriate speed when travelling off the sealed road.

Tyres

Ensure Tyres are correctly inflated to the required pressure. Refer to Vin Plate for the camper specific tire pressure.

Trailer training course

If you have never or rarely towed a trailer, caravan, or camper trailer, it may be best to complete a trailer training course to become familiar with the function and safety aspects of the trailer.

Wheel Bearings

Wheel Bearings should be checked every 5000km or annually. Never enter a water course/river crossing/beach with hot bearings, allow the bearings and wheel hubs to cool before you enter the water, this may result in significant damage to the Wheel Bearings.

Wheel Nuts

Wheel nuts need to be regularly checked and tensioned to the specific torque rating as indicated by the hub manufacturer. Our current default torque setting is 150Nm. Wheel nuts needs to be checked at 50 km and 100km after you have picked up the new camper trailer, and thereafter as per the hub manufacturer's recommendation. Ensure this process is completed when the wheels and hubs are cold.

About yourcamper

Specifications

Specifications apply to: BLUEWATER XTRAVELLER	2022 Model Only
Finish	Aluminium Composite – Colors vary
Trailer Measurements (towing Size)	5.9m long x 1.95m wide x 2.05m tall
Fridge Slide Measurements	1230mm Long x 580mm High x 540mm Wide
Water Tanks	1 X 120L + 1 X 80L Fresh Water – TOTAL 200L
Structure	Aluminium Composite Walls and Roof, Hot Dip Galv Drawbar, Full 75x50x4.0mm RHS Chassis and cross beams
Drawbar	120 x 50 x 4.0mm RHS Extended drawbar for easy corner turning and easy reversing. Hot Dip Galv
Safety Chains	Dual drawbar safety chains rated
Suspension	Independent suspension with dual Ridepro shock absorbers each side, trailing arm and coil spring
Brakes	12" electric brake system, easy in soft conditions, meaning lower tyre wear and adjustable hand brake
Wheels & Tyres	4 x Brand New 16" (Toyota 6 Stud Pattern 139.7PCD Zero Offset) Alloy wheels with MT or AT tyres 265/75
Hitch	Cruisemaster DO35 3500kg
Tare Weight	Refer to your trailers compliance plate as may vary with Options. Standard is 1750kg
Aggregate Trailer Mass (ATM)	2400kg
Ball Weight (At Tare)	200kg
Jockey Wheel	ARK XO750 Off Road Twin Wheel Jockey
Jerry Can Holders	2 x 20ltr Jerry Can Tie Down Loops
Gas Bottle Holders	1 x 8.5kg + 1 X 3.75kg Gas Bottle Holders
Kitchen	Stainless steel kitchen, sink with drainer and hose, BBQ Bench, Fold over Food Prep, Storage Drawers
Lights	LED Submersible Tail Lights and Number-Plate Light
Stabilizer Legs	4 x Heavy Duty Adjustable Drop-Down

Bearings and Seals

Bearings are a consumable item should be removed, inspected and repacked with grease every 5,000km and replaced every 10,000km as best practice. See maintenance schedule for guidance.		
Bearing Number: Inner Bearing 25580 Cone: 25520	Outer Bearing 15123 Cone: 15245	Seal: 2.25 x 3.371 x 0.375

Fridge Fitting Chart

Dimensions: 975mm Long x 650mm High x 560mm Wide

Dometic	Engel	Evakool	Bushman	Ironman	ARB	Kickass
CFX 50	MT35FP	RF40	35L	30L	Elements 60L	KA45
CFX 65	MT45FP	RF47	45L	40L	35L	KA61
CFX65DZ	MT60FP	TMX35	42L	65L	47L	KA80
CF80ACVERB1	MT60FCP	Glacier 30	52L	74L	60L	KA75
CF-110ACVERB	MT80FP	GFM55			78L	KA95
CFX95DZ	MT80FCP	TMX45				
CFX375DZ		Glacier 45				
CFX355IM		TMX55				
		ED45				
		Glacier 80				
		Glacier 74	EVAKOOL			
		TMX50	TMDZ62			
		Glacier 55	TMDZ80			
		TMX65	TMDZ95			

Hitch

Your camper is fitted with an ADR compliant Cruisemaster DO35 V3Plus Off-Road hitch. [Cruisemaster DO35 V3](#). It is important to maintain and inspect the hitch regularly as per the maintenance schedule. The hitch should be attached to the vehicle tow bar as per the instructions outlined below. The hitch has grease points and should be used to grease during every service. Your camper is supplied with a user guide for the DO35 Hitch, please read thoroughly before use.



HITCHING UP WITH THE DO35

- STEP 1**
Ensure the Tow Pin Cover is removed from Tow Pin.
- Step 2**
The Tow Pin and Universal should be free of sand, dirt and foreign objects. Lightly lubricated to ensure premature wear is avoided.
- Step 3**
Set the coupling to the unlocked position. Do so by pushing down on the Red Lock Button while simultaneously pushing back the Locking slide plate towards the Red Lock Button. When in position the Lock Button will spring back and pressure will be removed from the Locking Plate. At this stage in the unlocked position the viewing port in the centre of the locking mechanism should be clear.
- Step 4**
Raise height of trailer so the coupling is above the vehicle Tow Pin height by adjusting Jockey Wheel or Stand.
- Step 5**
Align Coupling over Tow Pin by moving either vehicle or trailer, then lower coupling onto tow pin using Jockey Wheel or Stand. Ensure that the Universal is fully seated on the Tow Pin; the Tow Pin will protrude through locking plate as visible via the view port.
- Step 6**
Once in position Push the same Red Lock Button used in Step 3 to reset the locking plate into the locked position. The Locking Plate will slide forward into place simultaneously to the button push.
- Step 7**
Secure the Checklock Cap, the cap will emit an audible snap when secured correctly.

For video instructions visit <http://cruisemaster.com.au/> videos or search on YouTube "Cruisemaster - Hitching Up with the DO35"

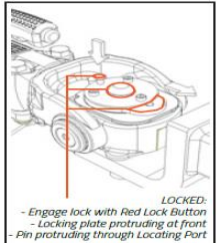
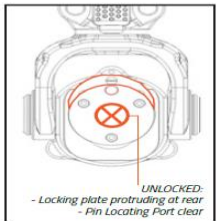

Canvas Annex Care

Seasoning the Canvas

The process of seasoning your canvas before use is an important one but fortunately an easy process. This process is best done on a warm sunny day with no rain expected.

- Set up your camper and annex with all doors and windows zipped up and closed
- Using your garden hose apply a light spray of water over all the external canvas areas. Wet out the canvas without allowing water to pool in any section then allow to dry thoroughly.
- Repeat the process of wetting and allowing to dry another 2 times.
- On the third wetting check for any leaks in the canvas particularly along the seams. If a seam is weeping water through, allow the canvas to thoroughly dry then apply a wax stick along the area of the seam. This is done by lightly rubbing the wax stick over the area. Once applied wet the canvas and check again. NOTE: It is not unusual for seams that aren't able to be seam sealed with tape to weep after seasoning. This is not a reflection of canvas or workmanship but simply a characteristic of canvas tents. If the leak persists, contact your Eagle Outdoors customer representative.

Protecting Seams and Screens

Seams: When erecting any canvas tent, it is vitally important that you don't stress the canvas by overtightening when adjusting the poles. The most common cause of damage to canvas is over tensioning. Adjusting the tent should give the canvas good shape but the material should be relaxed. If you can see the stitching exposed in a seam, then the canvas is under strain and the pole should be backed off.

Screens: Fly mesh screens are vulnerable to damage by poles rubbing against it. When packing up your camper it is important to close windows with both inner and outer canvas zipped up thus protecting the mesh. Never leave door screens rolled up when packing your camper as this can cause harsh creases and damage the screen. Mesh damage by owner misuse is not a warranty issue.

Zipper Care

Few parts of your camper work as hard as zippers particularly if you have young children. To get the maximum service life from zippers there are precautions and maintenance you can do.

Never force a zipper. If it jams or becomes difficult back it up and start again ensuring the two rows are feeding evenly into the slide without one row having much greater weight of canvas than the other. Avoid having doors half zipped when the tent is in use. Leaving the slider in a poor position while the door canvas flaps around, or people access the door pushing the canvas out of the way can loosen and damage the teeth. Always fully open or close the entry doors on your tent. Dry lubricant spray is a great way to make zipping up your tent easier. Apply a light coating of dry lubricant along the length of the zipper as needed.

Protecting from Mould & Moisture

Mould is very difficult to clean once a tent is affected. There are several ways you can prevent the occurrence of mould on your canvas. Never leave your canvas packed away wet. If you must leave a campsite with wet canvas, be sure to open and dry out your annex thoroughly at the very first opportunity when you get home.

Mould can develop in just a couple of days so don't take the risk.

It is important to check under the mattress that there is no build-up of condensation overnight. Body heat on a mattress can create enough temperature difference with the exterior for moisture to form under it. If left unchecked this can cause mould when your camper is stored. Bird droppings can damage your canvas due to the Ph level. Always clean off any animal dropping as soon as possible. When storing your camper between camping trips it is recommended you pack a couple of moisture absorber packs into your camper.

There are many ways moisture can appear in campers and caravans with condensation being the most common. Condensation happens when moisture laden air cools and condenses into water. This can be because of something as simple as packing your camper up on a warm humid day or condensation forming because of a dew point under your camper mattress.

We can't prevent this, but we can implement ways to control it with the most effective being moisture absorbing products. These canisters and sachets do a fantastic job of removing moisture, so it doesn't form on textile surfaces like canvas.

Simply place a sachet or two under your mattress and a couple of canisters in the camper or caravan and they will absorb much of the moisture in the air.

Between using these and ensuring good seal compression on your camper, it will give you the best possible prevention against mold.

Moisture absorbers can be purchased from hardware stores and most supermarkets and are cheap insurance against mold and mildew.



Setting up your Camper

Loading Your Caravan

It is important to load your camper correctly to distribute weight evenly and achieve a suitable ball weight load and prevent loading in a manner that can cause a caravan to sway and/or roll excessively left and right. The optimum ball weight on a camper is between 9 and 11% of the total camper weight.

WARNING: BALL LOADING (DOWNWARD LOAD ON TOW HITCH) MUST NOT EXCEED 350KG OR THE MAXIMUM ALLOWABLE LOAD BY THE VEHICLE MANUFACTURER OR TOW BAR RATING, WHICH EVER IS THE LOWEST. Exceeding these limits may result in an accident causing serious injury or death and/or property damage.

- Always load evenly to both sides of the camper
- Load heavy weight over or as close to over the axle as possible and as low as possible
- Overhead cupboards should only be used for lightweight items such as clothes, personal items, bedding etc.
- Heavy cooking equipment should be stored in lower cupboards.
- Tinned food, bottled goods for cooking etc should be stored in the pantry cupboard.
- Never load in a manner that causes the ball weight to exceed the limit of the tow vehicle.
- Ensure no items can move during travel. Secure all items to prevent damage to the camper..
- Consider water tank levels and how they may affect the balance front and back and the percentage of ball weight.
- Never store heavy items in overhead cupboards.

The diagram below illustrates best placements of items based on weight.

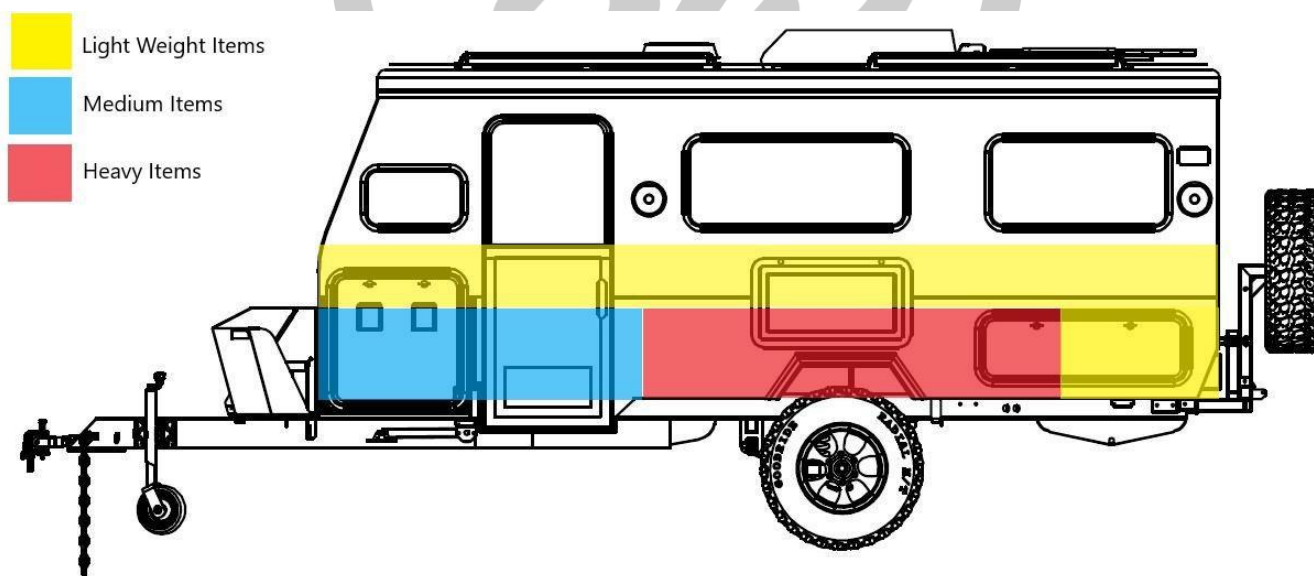

Choosing a Spot to Set Up

When choosing a spot to set up your camper, start with a flat area with no overhanging trees. Birds and bats occupying trees can defecate leaving droppings on your camper that can damage paint and canvas and leaves and sap can also taint the canvas. Ensure you are not camping in an area prone to flooding or with bad drainage in the event of rain. Even the slightest hollow in the ground can put you in a mini lake. In hot weather if possible, set your camper up so the sun's arc goes from front to back or back to front with the annex/awning in the general direction the sun is arcing across. Doing this will keep the bulk of the camper in shade and the inside cooler as it will be protected

by the tropical roof and shaded by the awning.

Levelling Your Camper

The stabilizer legs on your camper/caravan are not designed for supporting the full weight of the trailer, they are there to stabilize it once it is level. Using your stabilizers as a lifting mechanism will void your warranty as will extending them with a “rattle gun” or “impact wrench”. Levelling front to back can be done by raising and lowering the jockey wheel prior to adjusting the stabilizer legs. Getting the trailer level from left to right should be done with drive on stepped ramps as illustrated below. Once levelled the legs can be lowered to keep the trailer stable. On soft ground you may want to use timber sole boards under the stabilizer feet.



Site Power

Your camper has a 240V system with 15Amp Power inlet. You will need a 15Amp extension lead to plug into the camper, to supply power to the inside 10A power outlets. The Projecta charger in your camper should be plugged in at all times into the power point mounted under the seat, and switched on.. Never leave power leads coiled when in use, lay the lead out back and fold in a manner that won't be a trip hazard or risk damage to the lead. If the site power is not RCD protected it is recommended to use a portable RCD device.

Pole Diagram

① x7

⑥ x1

D5

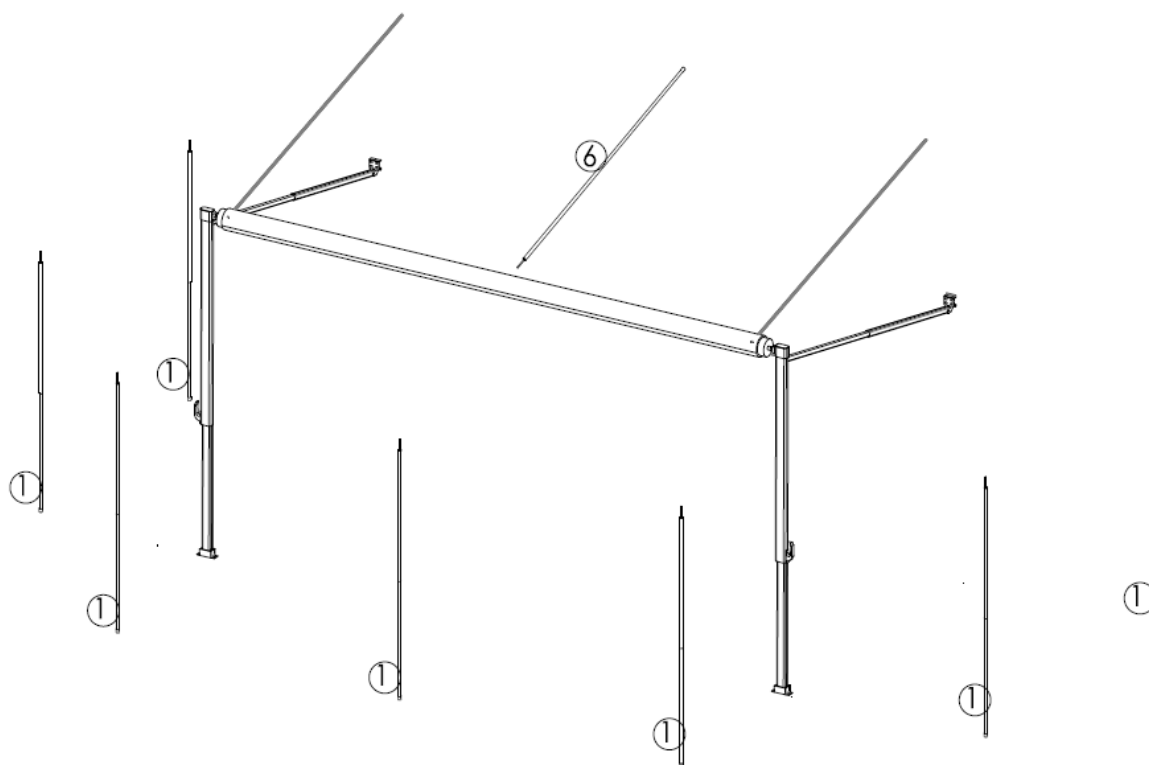

Preparing for Bad Weather

During inclement weather, the following should be done:

- Close all roof vents and hatches to prevent water entering.
- Protect the awning from high winds by retracting or securing with guy ropes and pegs.
- Ensure your caravan is not parked in ground that will become boggy and prevent exiting the camp area
- Close all external doors and hatches to prevent water ingress and wind damage

Packing Away Your Camper

When packing down your camper ensure the following:

- All gas and electric appliances are turned off
- Gas is turned off at the gas bottle
- All loose items are secured and unable to move and damage themselves or the camper
- All cabinet doors are secured and locked along with all drawers closed
- Roof is lowered, and over centre latches are locked with safety pin engaged
- Site power lead is removed and stowed
- Doorstep is raised and secured
- All roof hatches lowered and secure
- All windows closed and locked
- Main door is closed and locked
- All dust covers in place and secure
- Secure Ensuite doors and close toilet

Storage & Care

Long Term Storage

To maximize the life of your camper/caravan you should consider additional protection from the elements. UV light and moisture can have an adverse effect on materials when left unprotected outside. This section outlines some of the things you can do as an owner to protect your investment.

Interior

Moisture in the smallest amounts can cause mould. High humidity and cooling temperatures can create condensation, additionally condensation can form under mattresses due to temperature differences between warm bodies on top and the bed base being cold from outside temperatures. As a precaution you can do the following:

- Check under mattress for moisture before packing up. If moisture is found allow to thoroughly dry before closing your camper.
- Store 1 or 2 moisture absorbing packs/dehumidifier packs in the camper/caravan to draw away any residual water vapor.
- If packing up with damp canvas, open and dry out the camper at the first opportunity when returning home. Dry all canvas thoroughly and follow point 2.

Exterior

Ensure all seals on the caravan have proper compression at 30-50%, are free of dirt and have nothing protruding past the seals. UV light and the elements can over time cause seals and fittings to perish and become brittle. The use of a caravan cover will extend the life of components and keep your investment looking better for longer.

It is recommended the water tanks are drained after each use, to prevent bacteria possibly growing in the water tank. The tank should be flushed before filling with fresh water also.

Batteries

When storing your caravan, ensure all power is turned off to ensure batteries aren't drained. Batteries should be maintenance charged at least monthly when stored. Allowing batteries to drain below 12.05 volts may permanently damage them.

Care of Paint and Surfaces

Paintwork

The paint coatings on your camper are no different to that of your car in that they need regular care and maintenance.

Washing: Only use mild detergents free of ammonia when washing your camper. Always check the label to ensure the washing solution is nonabrasive, contains no ammonia or caustics.

Polishing: New campers should only be polished with wax-based polishes that are nonabrasive. When removing scratches from paintwork use a fine finishing compound. Cutting pastes are too abrasive and will expose the base material.

Protection: Carnauba wax is an excellent protection against oxidization. The paint on your camper should be waxed annually regardless of being kept under cover to protect the surfaces from oxidization.

Internal Surfaces

Laminates and internal wall surfaces should be cleaned with a damp soft cloth. For stubborn marks use a mild detergent based cleaner.

****Do not use cleaners that contain ammonia or caustics****

Acrylic Windows

Windows should be cleaned with a clean, soft, nonabrasive cloth to avoid scratches and soapy water.

****Do not use any cleaners that contain ammonia or solvents. ****

Mirrors

Do not use solvents or chemicals when cleaning mirrors. Warm water and a soft clean cloth is the best method. Cleaners and solvents may affect the reflective backing causing what's known as "creep" where the edges of the mirror discolor.

Shade and screen care

- Do not close blinds while window is open. Air pressure can dislodge the blind material from its guide damaging it.
- Always open and close blinds and screens carefully and evenly with two hands ensuring screens and blind material feeds evenly through the guides.

Securing Your Camper

When parked and unhitched you should always use suitable wheel chocks to ensure the trailer can't move in the event of a handbrake failure. For security, a wheel clamp or and hitch lock are highly recommended.



Maintenance

Maintenance is essential to keep your camper in a safe and usable condition. Campers are no different to any other motor vehicle and require servicing at regular intervals which may vary according to use and the environment in which it is used. The service schedule outlines the service intervals for safe travelling and your owner obligations under our warranty policy. Servicing should always be carried out by a competent person with relevant experience. The wheel nuts must be checked after travelling the first 200klms, then periodically during every trip. Wheel bearings must be checked after travelling the first 1000klms from brand new, to ensure they have “bedded” in properly and still seated in the correct position.

Periodically check your tyres for abnormal wear. Your suspension is adjustable just like your car, and can be subject to movement especially in off road conditions. If you notice abnormal wear you should seek a wheel alignment as soon as possible

Recommended tyre pressure for highway use is 45PSI at TARE Weight. Your tyre pressures should adjusted to suit the many variable off road conditions you may encounter, this will help reduce the risk of punctures or tyre damage.

WARNING:

- Never work beneath the camper while suspended on a jack. Always use “Jack Stands” with an adequate SWL.
- Always use dedicated jacking points
- 240volt appliances and wiring must only be serviced and repaired by a qualified tradesperson.
- Gas plumbing must only be serviced and repaired by a qualified gas fitter

Maintenance Schedule

Item	Details	First 50	3 Months	1000km	6 Months	12 Months	18 Months	24 Months	Notes	
		& 100km	500km		5000km	10,000km	15,000km	20,000km		
Hitch	Inspect for damage, wear and lubricate. Check torque on bolts to 76Nm	X	X	X	X	X	X	X	Check every 1000km in offroad conditions	
Handbrake	Check cables for damage and adjust when lever extends beyond 3/4.		X		X		X		Or as required	
Jockey Wheel	Lubricate & check for stability and secure locking			X		X		X		
Hand winch & webbing	Lubricate & check webbing for damage			X	X	X	X	X	Inspect webbing each use	
Suspension Pivots & Bushes	Lubricate and check for excess movement. Check torque on bolts. 190Nm			X	X	X	X	X	Lubricate every 500km when experiencing water crossings or flooding	
Brakes & Linings	Remove drum and inspect lining thickness. Adjust Brakes	X	X		X	X	X	X	Every 2500km when using offroad	
Wheel bearings & seals	Inspect, clean and relubricate			X	X	X	X	X	Inspect every 2500km when experiencing water crossings or flooding	
Wheel Nuts	Check torque @ 125Nm (12mm studs) 140nm (14mm studs with alloy wheels 200nm (14mm studs) Steel Rims	X	X	X	X	X	X	X	Daily when travelling	
Tyres	check pressure and inspect for damage			Each time you use your camper						Pre Every Use
Lights	Check all lights operating			Each time you use your camper						Pre Every Use
Batteries	Inspect terminals and test voltage & maintenance charge			Use maintenance charge or check & charge Monthly						Use maintenance charge or check & charge Monthly
Gas system	Leak test using gas fuse				X		X			
Body seals	Check condition and flexibility as well as compression when closed. Adjust locks if necessary			Each time you use your camper						Inspect for damage each pack up and adjust locks if necessary
General fixings	Check all nuts and bolts ensuring none are loose. See torque settings for structural bolts		X	X	X	X	X	X	Inspect every 2500km in offroad conditions	

500KM FIRST SERVICE		CHECKED
Hitch	Check hitch bolts to 76Nm. Lubricate with high temp bearing grease	
Handbrake	Inspect and adjust handbrake	
Brakes	Inspect and adjust brakes	
Wheel nuts	Inspect condition and torque to 125Nm (12mm studs) (140Nm 14mm studs alloy rims) (200Nm 14mm studs steel rims)	
Tyres	Inspect for abnormal wear and damage	
General fixings	Ensure no loose fittings	
Date:	Service Person:	
Dealer Stamp:		

6 MONTHS / 5,000KM SERVICE		CHECKED
Hitch	Check hitch bolts to 76Nm	
Handbrake	Check cable and adjust if necessary	
Hand winch	Check brake function and webbing	
Suspension	Lubricate and check bushes for excess movement. Torque bolts to 190Nm	
Brakes	Inspect and adjust. Check lining thickness and drum wear	
Wheel bearings	Remove, clean and re-lubricate. Inspect for wear and replace if necessary	
Wheel Nuts	Inspect condition and torque to 125Nm (12mm studs) (140Nm 14mm studs alloy rims), (200Nm 14mm studs steel rims)	
Tyres	Check for damage and pressure	
Lights	Check all lights are functioning	
Battery	Check terminals and voltage at full charge	
Seals	Check condition and correct latch/lock adjustment for correct 30-50% compression	
General fixings	Check all structural fixing are secure.	
Date:	Service Person:	
Dealer Stamp:		

12 MONTHS / 10,000KM SERVICE		CHECKED
Hitch	Inspect for damage and lubricate. Check bolt Torque to 76Nm	
Jockey Wheel	Inspect for condition and operation	
Hand winch	Check brake function and webbing	
Suspension	Lubricate and check bushes for excess movement. Torque bolts to 190Nm	
Brakes	Inspect and adjust. Check lining thickness and drum wear	
Wheel bearings	Replace bearings, seals and lubricate. Check stub axle condition and wear. Replace split pin.	
Wheel Nuts	Inspect condition and torque to 125Nm (12mm studs) (140Nm 14mm studs alloy rims) (200Nm 14mm studs steel rims)	
Tyres	Check for damage and pressure	
Lights	Check all lights are functioning	
Battery	Check terminals and voltage at full charge	
Seals	Check condition and correct latch/lock adjustment for correct 30-50% compression	
General fixings	Check all structural fixing are secure.	
Date:	Service Person:	
Dealer Stamp:		

18 MONTHS / 15,000KM SERVICE		CHECKED
Hitch	Inspect for damage and lubricate. Check bolt Torque to 76Nm	
Jockey Wheel	Inspect for condition and operation	
Hand winch	Check brake function and webbing	
Suspension	Lubricate and check bushes for excess movement. Torque bolts to 190Nm	
Brakes	Inspect and adjust. Check lining thickness and drum wear	
Wheel bearings	Replace bearings, seals and lubricate. Check stub axle condition and wear. Replace split pin.	
Wheel Nuts	Inspect condition and torque to 125Nm (12mm studs) (140Nm 14mm studs alloy rims) (200Nm 14mm studs steel rims)	
Tyres	Check for damage and pressure	
Lights	Check all lights are functioning	
Battery	Check terminals and voltage at full charge	
Seals	Check condition and correct latch/lock adjustment for correct 30-50% compression	
General fixings	Check all structural fixing are secure.	
Date:	Service Person:	
Dealer Stamp:		

24 MONTHS / 20,000KM SERVICE		CHECKED
Hitch	Inspect for damage and lubricate. Check bolt Torque to 76Nm	
Jockey Wheel	Inspect for condition and operation	
Hand winch	Check brake function and webbing	
Suspension	Lubricate and check bushes for excess movement. Torque bolts to 190Nm	
Brakes	Inspect and adjust. Check lining thickness and drum wear	
Wheel bearings	Replace bearings, seals and lubricate. Check stub axle condition and wear. Replace split pin.	
Wheel Nuts	Inspect condition and torque to 125Nm (12mm studs) (140Nm 14mm studs alloy rims) (200Nm 14mm studs steel rims)	
Tyres	Check for damage and pressure	
Lights	Check all lights are functioning	
Battery	Check terminals and voltage at full charge	
Seals	Check condition and correct latch/lock adjustment for correct 30-50% compression	
General fixings	Check all structural fixing are secure.	
Date:	Service Person:	
Dealer Stamp:		

30 MONTHS / 25,000KM SERVICE		CHECKED
Hitch	Inspect for damage and lubricate. Check bolt Torque to 76Nm	
Hand brake	Check cable and adjust if necessary	
Hand winch	Check brake function and webbing	
Suspension	Lubricate and check bushes for excess movement. Torque bolts to 190Nm	
Brakes	Inspect and adjust. Check lining thickness and drum wear	
Wheel bearings	Remove, clean and re-lubricate. Inspect for wear and replace if necessary	
Wheel Nuts	Inspect condition and torque to 125Nm (12mm studs) (140Nm 14mm studs alloy rims) (200Nm 14mm studs steel rims)	
Tyres	Check for damage and pressure	
Gas System	Leak, test, check stove operation and hose/coupling condition	
Battery	Check terminals and voltage at full charge	
Seals	Check condition and correct latch/lock adjustment for correct 30-50% compression	
General fixings	Check all structural fixing are secure.	
Date:	Service Person:	
Dealer Stamp:		

36 MONTHS / 30,000KM SERVICE		CHECKED
Hitch	Inspect for damage and lubricate. Check bolt Torque to 76Nm	
Jockey Wheel	Inspect for condition and operation	
Hand winch	Check brake function and webbing	
Suspension	Lubricate and check bushes for excess movement. Torque bolts to 190Nm	
Brakes	Inspect and adjust. Check lining thickness and drum wear	
Wheel bearings	Replace bearings, seals and lubricate. Check stub axle condition and wear. Replace split pin.	
Wheel Nuts	Inspect condition and torque to 125Nm (12mm studs) (140Nm 14mm studs alloy rims) (200Nm 14mm studs steel rims)	
Tyres	Check for damage and pressure	
Lights	Check all lights are functioning	
Battery	Check terminals and voltage at full charge	
Seals	Check condition and correct latch/lock adjustment for correct 30-50% compression	
General fixings	Check all structural fixing are secure.	
Date:	Service Person:	
Dealer Stamp:		

42 MONTHS / 35,000KM SERVICE		CHECKED
Hitch	Inspect for damage and lubricate. Check bolt Torque to 76Nm	
Hand brake	Check cable and adjust if necessary	
Hand winch	Check brake function and webbing	
Suspension	Lubricate and check bushes for excess movement. Torque bolts to 190Nm	
Brakes	Inspect and adjust. Check lining thickness and drum wear	
Wheel bearings	Remove, clean and re-lubricate. Inspect for wear and replace if necessary	
Wheel Nuts	Inspect condition and torque to 125Nm (12mm studs) (140Nm 14mm studs alloy rims) (200Nm 14mm studs steel rims)	
Tyres	Check for damage and pressure	
Gas System	Leak, test, check stove operation and hose/coupling condition	
Battery	Check terminals and voltage at full charge	
Seals	Check condition and correct latch/lock adjustment for correct 30-50% compression	
General fixings	Check all structural fixing are secure.	
Date:	Service Person:	
Dealer Stamp:		

48 MONTHS / 40,000KM SERVICE		CHECKED
Hitch	Inspect for damage and lubricate. Check bolt Torque to 76Nm	
Jockey Wheel	Inspect for condition and operation	
Hand winch	Check brake function and webbing	
Suspension	Lubricate and check bushes for excess movement. Torque bolts to 190Nm	
Brakes	Inspect and adjust. Check lining thickness and drum wear	
Wheel bearings	Replace bearings, seals and lubricate. Check stub axle condition and wear. Replace split pin.	
Wheel Nuts	Inspect condition and torque to 125Nm (12mm studs) (140Nm 14mm studs alloy rims) (200Nm 14mm studs steel rims)	
Tyres	Check for damage and pressure	
Lights	Check all lights are functioning	
Battery	Check terminals and voltage at full charge	
Seals	Check condition and correct latch/lock adjustment for correct 30-50% compression	
General fixings	Check all structural fixing are secure.	
Date:	Service Person:	
Dealer Stamp:		

54 MONTHS / 45,000KM SERVICE		CHECKED
Hitch	Inspect for damage and lubricate. Check bolt Torque to 76Nm	
Hand brake	Check cable and adjust if necessary	
Hand winch	Check brake function and webbing	
Suspension	Lubricate and check bushes for excess movement. Torque bolts to 190Nm	
Brakes	Inspect and adjust. Check lining thickness and drum wear	
Wheel bearings	Remove, clean and re-lubricate. Inspect for wear and replace if necessary	
Wheel Nuts	Inspect condition and torque to 125Nm (12mm studs) (140Nm 14mm studs alloy rims) (200Nm 14mm studs steel rims)	
Tyres	Check for damage and pressure	
Gas System	Leak, test, check stove operation and hose/coupling condition	
Battery	Check terminals and voltage at full charge	
Seals	Check condition and correct latch/lock adjustment for correct 30-50% compression	
General fixings	Check all structural fixing are secure.	
Date:	Service Person:	
Dealer Stamp:		

60 MONTHS / 50,000KM SERVICE		CHECKED
Hitch	Inspect for damage and lubricate. Check bolt Torque to 76Nm	
Jockey Wheel	Inspect for condition and operation	
Hand winch	Check brake function and webbing	
Suspension	Lubricate and check bushes for excess movement. Torque bolts to 190Nm	
Brakes	Inspect and adjust. Check lining thickness and drum wear	
Wheel bearings	Replace bearings, seals and lubricate. Check stub axle condition and wear. Replace split pin.	
Wheel Nuts	Inspect condition and torque to 125Nm (12mm studs) (140Nm 14mm studs alloy rims) (200Nm 14mm studs steel rims)	
Tyres	Check for damage and pressure	
Lights	Check all lights are functioning	
Battery	Check terminals and voltage at full charge	
Seals	Check condition and correct latch/lock adjustment for correct 30-50% compression	
General fixings	Check all structural fixing are secure.	
Date:	Service Person:	
Dealer Stamp:		

66 MONTHS / 55,000KM SERVICE		CHECKED
Hitch	Inspect for damage and lubricate. Check bolt Torque to 76Nm	
Hand brake	Check cable and adjust if necessary	
Hand winch	Check brake function and webbing	
Suspension	Lubricate and check bushes for excess movement. Torque bolts to 190Nm	
Brakes	Inspect and adjust. Check lining thickness and drum wear	
Wheel bearings	Remove, clean and re-lubricate. Inspect for wear and replace if necessary	
Wheel Nuts	Inspect condition and torque to 125Nm (12mm studs) (140Nm 14mm studs alloy rims) (200Nm 14mm studs steel rims)	
Tyres	Check for damage and pressure	
Gas System	Leak, test, check stove operation and hose/coupling condition	
Battery	Check terminals and voltage at full charge	
Seals	Check condition and correct latch/lock adjustment for correct 30-50% compression	
General fixings	Check all structural fixing are secure.	
Date:	Service Person:	
Dealer Stamp:		

Torque Settings

Wheel Nuts

Wheel nuts should be tightened to correct torque using a torque wrench. Never trust a “rattle gun” as these may over or under tighten. A quality torque wrench will ensure nuts are tightened correctly. It’s important to remember to check your wheel nuts at 50km, 500km and 1000km and periodically thereafter. The correct torque setting of 125Nm for 12mm studs, 140Nm for 14mm studs and alloy wheels and 200Nm for 14mm studs with steel rims.

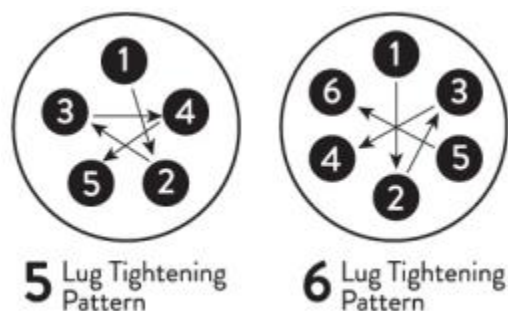

Hitch

The high tensile bolts securing your hitch should be tightened to 76Nm. These should be checked at 5000km intervals or 2500km in harsh off-road conditions.

Trailing Arm Pivot Bolts

The pivot bolts are a high tensile steel. The service interval for these bolts is 5000km under normal use and 2500km for harsh off-road conditions. During travel they should be inspected daily to ensure they have not rotated or become damaged. Correct torque is 190Nm

Brakes and Handbrake - Electric

Features

Your trailer is fitted with electric brakes that require a brake controller that can be operated from the driver’s seat.

1. Manual adjusted to provide the correct braking capability for varying road, off-road and load conditions.
2. They can be modulated to provide more or less braking force, thus easing the brake load on the towing vehicle.
3. There is very little lag time between the moment the tow vehicle’s brakes are actuated and the moment the trailer brakes are actuated.
4. They can provide some braking independent of the tow vehicle in the event of an emergency.

Operation

When electrical current is fed into the system by the controller, it activates the electromagnets in the brakes. These electromagnets are energized and are attracted to the rotating surface of the drums which moves the actuating levers in the direction that the drums are turning thus applying pressure from the brake linings to the drum surface.

Breakaway Switch

By law, all trailers with an ATM of 2000kg or greater must have a “Breakaway System” to halt the trailer in the event it becomes detached from the tow vehicle whilst traveling. Your camper is fitted with this system with the switch mounted on the drawbar with a steel wire lanyard to connect to your tow vehicle. In the event that the caravan becomes detached, the lanyard will pull the pin from the breakaway switch and the onboard batteries will activate the brake system. The lanyard must be attached to a solid part of the vehicle. It is a mandatory requirement that power be supplied by the tow vehicle to the breakaway power source while towing. This is done via the 50amp Anderson Plug on the drawbar. Consult a qualified auto electrician to ensure this is fitted to your tow vehicle.

Breakaway Switch



Anderson Plug



CAUTION:

- DO NOT CONNECT THE BREAKAWAY LANYARD TO THE SAME POINT AS THE SAFETY CHAIN SHACKLES.
- DO NOT USE THE BREAKAWAY AS AN ALTERNATIVE TO THE HANDBRAKE AND DO NOT REMOVE THE PIN AS AN ALTERNATIVE SECURITY MEASURE. REMOVING THE PIN WILL RAPIDLY DISCHARGE THE BATTERIES.
- IT IS A MANDATORY REQUIREMENT THAT THE BREAKAWAY BATTERY SOURCE BE CHARGED DURING TOWING.
- NSW REQUIRES A BATTERY MONITOR VIEWABLE FROM THE DRIVERS POSITION WITH A MINIMUM OF A VISUAL ALARM FOR LOW BATTERY VOLTAGE

Trailer Plug Wiring

The following diagrams outline the correct wiring for 7 pin plugs

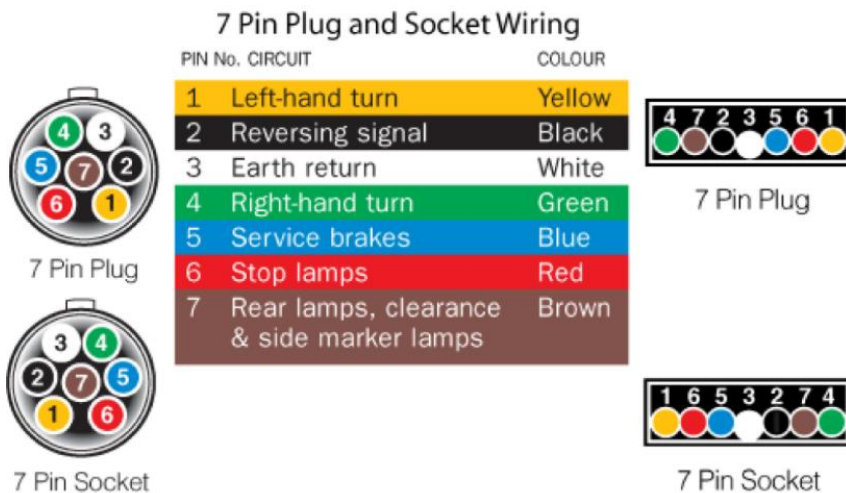

Hand Brake

Parking brakes are mechanically operated by cable means. The cable attachment occurs outside of the brake backing plate. Cable force applied to the parking lever creates a torque through the pivot pin and cam assembly. Torque transferred to the parking cam results in a spreading force between the primary and secondary shoes. The shoes in turn, move towards the drum until contact is made. Friction generated between the drum and lining contact surface results in parking brake capability.

Use the cable adjuster to give sufficient tension to be able to set the handbrake lever on the last two notches of the coupling or handbrake is 1/3 raised when unladen. This needs to be checked again when the trailer or caravan is loaded. If the cable is too tight, the brakes will be applied as the axle moves backward under spring deflection.

Hand Brake Adjuster

To adjust the handbrake cable tension release locknuts A and B in the diagram Handbrake Adjuster 1 below. To tighten the handbrake cable turn the adjuster wheel C in a clockwise direction. Once adjusted retighten lock nuts and test. Always ensure that wheels turn freely when handbrake is off. Overtightened cables can cause brakes to drag and damage the brake linings.

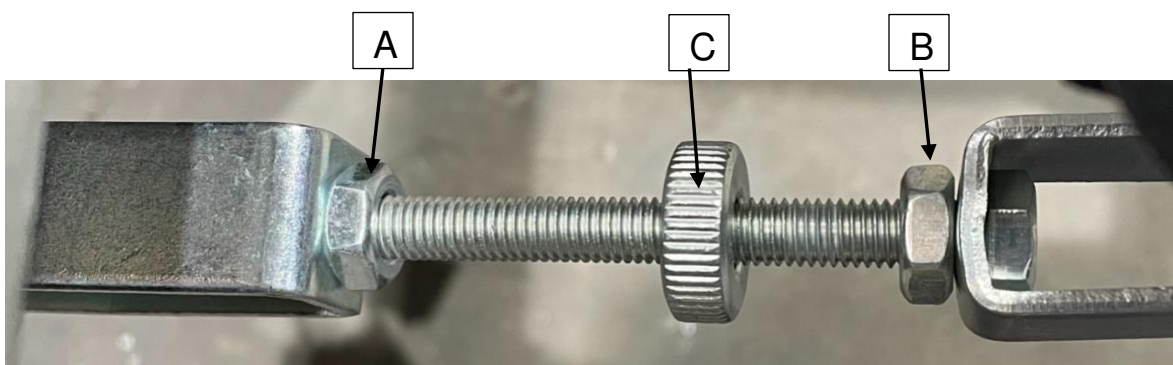

Correct Use of Your Electric Brakes

Your trailer brakes are designed to work in synchronization with your tow vehicle brakes. Never use your tow vehicle or trailer brakes alone to stop the combined load. Your trailer and tow vehicle will seldom have the correct amperage flow to the brake magnets to give you comfortable, safe braking unless you make proper brake system adjustments. Changing trailer load and driving conditions, as well as uneven alternator and battery output, can mean unstable current flow to your brake magnets. It is therefore imperative that you maintain and adjust your brakes as set forth in the controller manual, use a properly modulated brake controller and perform the synchronization/adjustment procedure recommended by the brake controller supplier.



Important Safety Notice

Proven and in some cases approved service methods and correct repair procedures are essential for the safe, reliable operation of the brakes, suspension and axles as well as the personal safety of the individual doing the work. This manual intends to provide general directions for performing service and repair work with tested, effective techniques. By following these guidelines, it will help assure

reliability. The numerous variations in procedures, techniques, tools and parts for servicing axles, as well as in the skill of the individual doing the work will determine outcomes. This manual cannot possibly anticipate all such variations nor provide advice or cautions as to each. Accordingly, anyone who departs from the instructions provided in this manual must first establish that they neither compromise their personal safety nor the vehicle integrity by their choice of methods, tool's or parts.

*If at all in doubt please refer all repairs and maintenance to a suitably qualified or experienced mechanical repairer.

*Eagle Outdoors accepts no liability for personal injury, loss or damage resulting from incorrect applications, methods and failure to perform maintenance safely and correctly.

Brake Adjustment

Brakes should be adjusted (1) after the first 300 km's of operation when the brake shoes and drums have "seated," (2) at 5000 km's intervals, (3) or as use and performance requires. The brakes should be adjusted in the following manner:



Never crawl under your trailer unless it is resting on properly placed jack stands. Do not place supports on any part of the suspension system and use the designated jack point or under the spring base plate to jack trailer.

Brake Cleaning and Inspection

Your trailer brakes must be inspected and serviced at 5000km or more often as required by use and performance. Magnets and shoes must be changed when they become worn or scored to avoid inefficient vehicle braking.

Brake Lubrication

This should only be done by qualified persons.



Caution

Do not get grease or oil on the brake linings, drums or magnets.

Magnets

Your electric brakes are equipped with high quality electromagnets that are designed to provide the proper input force and friction characteristics. Your magnets should be inspected and replaced if worn unevenly or abnormally.

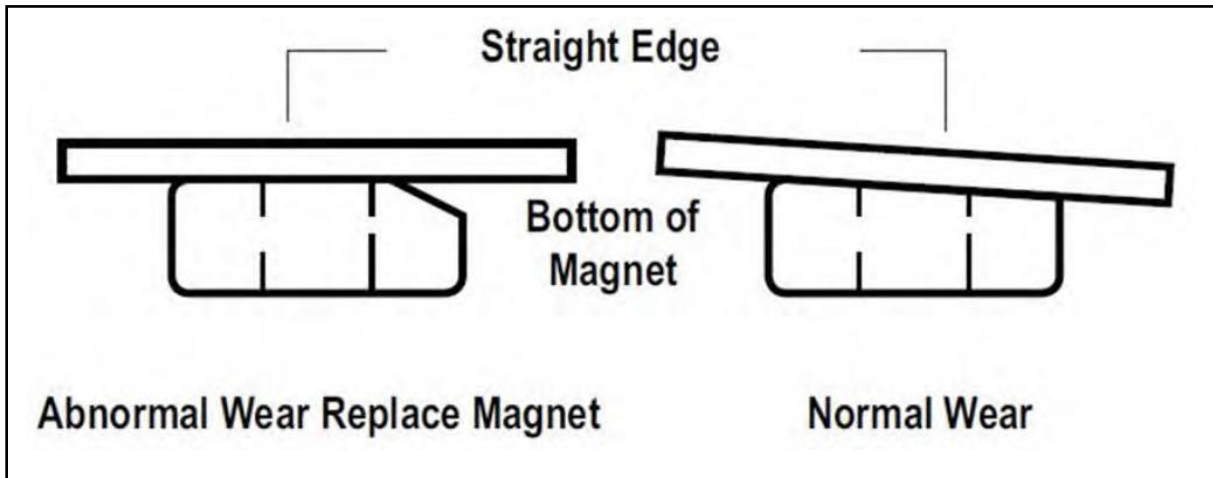

Even if wear is normal as indicated by your straightedge, the magnets should be replaced if any part of the magnet coil has become visible through the friction material facing of the magnet. It is also recommended that the drum armature surface be refaced when replacing magnets.

Magnets should also be replaced in pairs - both sides of the axle. Always use genuine Eagle Outdoors OEM parts.

Shoes and Linings

A simple visual inspection of your brake linings will tell if they are useable.

Replacement is necessary if the lining is worn (to within 1.5mm or less), contaminated with grease or oil or abnormally scored or gouged. It is important to replace both shoes on each brake and both brakes of the same axle. This is necessary to retain the "balance" of your brakes. Be sure to replace your shoes only with genuine Eagle Outdoors parts available from our outlets.

Corrosion Prevention

It's important to take steps to prevent corrosion of parts on your trailer to extend the service life. Many fittings are high tensile and therefore zinc plated. Fittings such as this can benefit from additional protection. Some helpful products to prevent corrosion are "Lanotec", "WD40", "Inox" and similar products. These can be spray applied and do a very good job of protecting metal surfaces, particularly in corrosive and aggressive environments near the ocean and inland waterways.

Often, we take our campers and caravans to salt water environments. Driving through salt water is never recommended as the residual chloride ions accelerate corrosion greatly. If you are camping near or driving through these kinds of environments we highly recommend that your trailer be thoroughly cleaned after use. Flushing the chassis and washing and rinsing your trailer is important.

Wheels and Tyres

Highway

Your caravan is fitted with 16" wheels and 265/75 R16 Tyres. The tyres are a "Light Truck" type with EITHER mud terrain OR All Terrain tread and a maximum load rating on single axle of 1550kg at 80psi.

Recommended highway pressure at tare weight of the caravan is 45psi. Recommended highway pressure at ATM of 2500kg is 55psi

Off Road

Off road driving requires lower tyre pressures and lower speeds. When driving on rough and corrugated road, a reduction of speed and controlled deflation of tyres is required to protect the caravan and its suspension from damage. In extreme circumstances tyre pressures may be reduced significantly. When lowering from highway pressure, a rule of thumb is to reduce your speed by the same percentage as the lowering of tyre pressure.

Because off road conditions can vary greatly, you must lower your pressures and reduce speed until vibration and shock through the suspension is at a moderate level to suit the conditions you are experiencing, and the loaded weight of your caravan.

WARNING: When returning to the highway or when increasing speed, you must reinflate the tyres to correct highway pressures. Failure to reinflate can cause severe handling problems resulting in injury or death.

Suspension

Your camper is fitted with quality independent trailing arm suspension with dual shock absorbers. This design is ideal for the full range of use on and off road however, there are limitations in prolonged use of corrugated and rough road.

Shock Absorbers & Bushes

The function of shock absorbers is to turn kinetic energy into heat and dampen the rebound in the suspension to keep the tyre in contact with the road. During prolonged periods on corrugated and rough roads it is possible to overheat shock absorbers to the point of failure (shock fade). Best practice is to take regular breaks and allow both the shock absorbers and suspension bushes to cool. Overheating the bushes through prolonged driving on corrugations can soften the thermoplastic and cause premature wear and/or deformation of the bush. On severely rough roads stop regularly up to every hour to allow components to cool.

Jacking Your Camper

Your Emu Xpedition has a bottle jack locating ring on each of the trailing arms on the suspension.

The jacking point on the trailing arm is designed for the head of a bottle jack to fit securely inside the metal ring. When using this point ensure the jack is on a solid base and the camper cannot move.

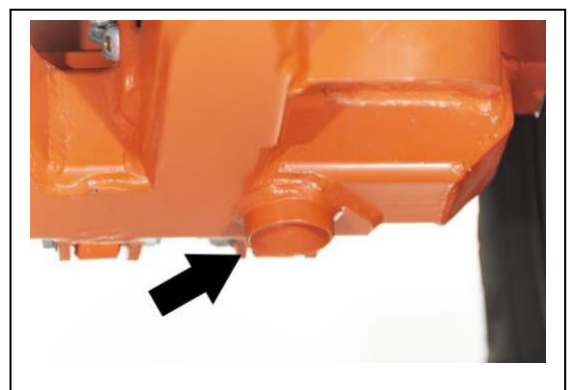

Electrical Systems

Chargers & Inverters

For detailed information on the appliances installed in your camper please refer to the manuals included in your camper handover. Your 2000/4000W Modified Sine Wave inverter can only be used when plugged directly into it, it is connected direct to the battery. It cannot be used on the inside power points, as they are for use only when connected to external 240V Power.



Caution

Electrical devices can be dangerous. Under no circumstances should repairs and modifications be attempted by unqualified or untrained persons. Eagle Outdoors accepts no liability for any personal injury, damages or loss as a result of unqualified or untrained persons repairing or altering the electrical systems on this product. If in doubt call your local Eagle Outdoors outlet or phone: 1300 500377

Battery Care

Your camper is fitted with 2 x 135ah BSL Lithium Batteries with in-built BMS. Storage type batteries require periodical maintenance to perform at their peak and extend their service life. The following is an outline on how to gain the best performance and lifecycle from the battery fitted in your camper:

- Always use a quality charger that caters to the voltage requirements of an Lithium battery. Absorption charging is from 14.6v to 14.8v, float charging is from 13.2v to 13.8v.
- Never leave your battery stored at low volts. Before storing your camper ensure that battery/s is fully charged and all power is disconnected/switched off.
- When possible, leave the battery connected to a smart charger that will cycle and maintain the battery during storage. If this isn't possible check and charge at regular intervals to prevent excessive discharge.
- Never use unregulated solar power direct to your batteries.
- When in use try to keep your battery at or as close to maximum capacity as possible.
- Allowing your battery voltage to drop below 11.5V can permanently damage its performance and reduce its service life.

BSLBATT Lithium Battery Bluetooth App

This battery has Bluetooth communication function. It connects to the mobile phone Bluetooth function to communicate with the Bluetooth device. The Bluetooth device and the BMS in the battery can be communicated. Users can read the battery status information directly through the mobile phone.

Main Status Information:

- Real time SOC
- Current Voltage
- Current Working Current (A)/ Power (W)
- Temperature
- Alarm Information
- Version Information



APP LOGO

Install Software – Search 'Smart BMS' in the app store then download the app.

Preparation before Use:

1. Open the mobile phone Bluetooth function.
2. Confirm that the battery is working normally and find the Bluetooth number on the top cover of the battery.

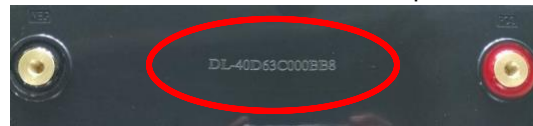

Bluetooth Connection.

1. Open the App
2. Single cell, Parallel, Series. Three Modes
 - a. Single Cell: to see a single battery data. Check the battery status information when the use of a single battery is used.
 - b. Parallel: to see the battery status information after multiple batteries. The SOC, voltage, current and power of the main interface of this mode are the overall state information after parallel batteries connected.
 - c. Series: To see the battery state information after multiple batteries. The SOC, voltage, current and power displayed on the main interface of this mode are the overall state information after series batteries connected.

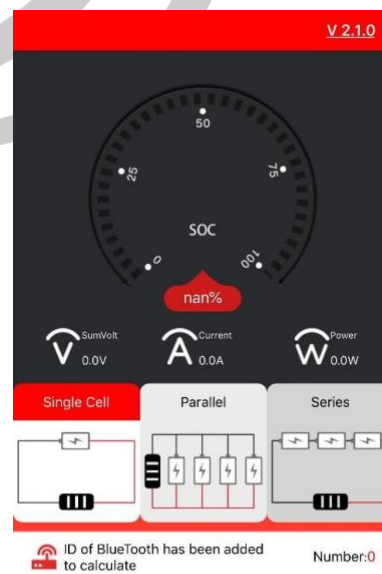

1. Single Cell
 - a. Select the number of the correct battery
 - b. Red '+' representative is to be selected, and the grey '-' represents the selected.

- c. You can only choose one, you can't choose more.
- d. Click the encoding to enter after selection.

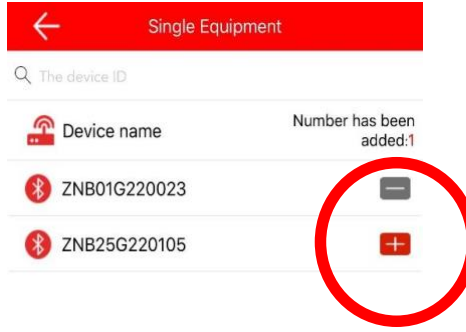
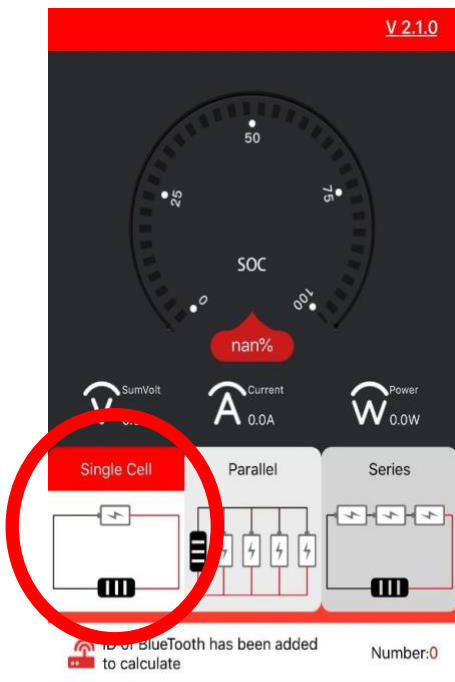

Click the main interface

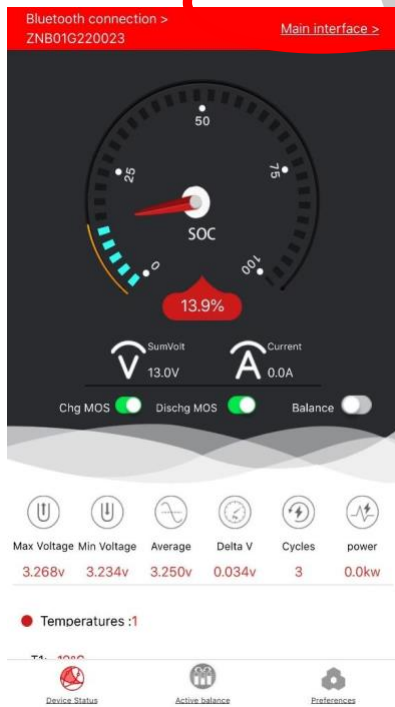

Battery Status Detail

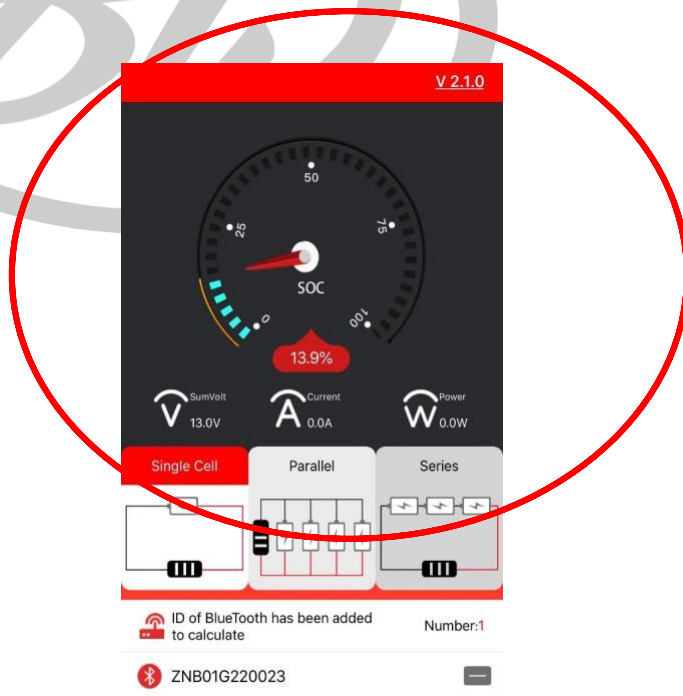

Main Interface - Main battery status info

2. Parallel

- Select the number of the correct battery, be sure to confirm that the battery has been connected in parallel and normal work.
- Red '+' representative is to be selected, and the grey '-' represents the selection. Choose a maximum of 6 units, cannot be more.
- After Selecting, click the arrow in the upper left corner to enter the main interface.

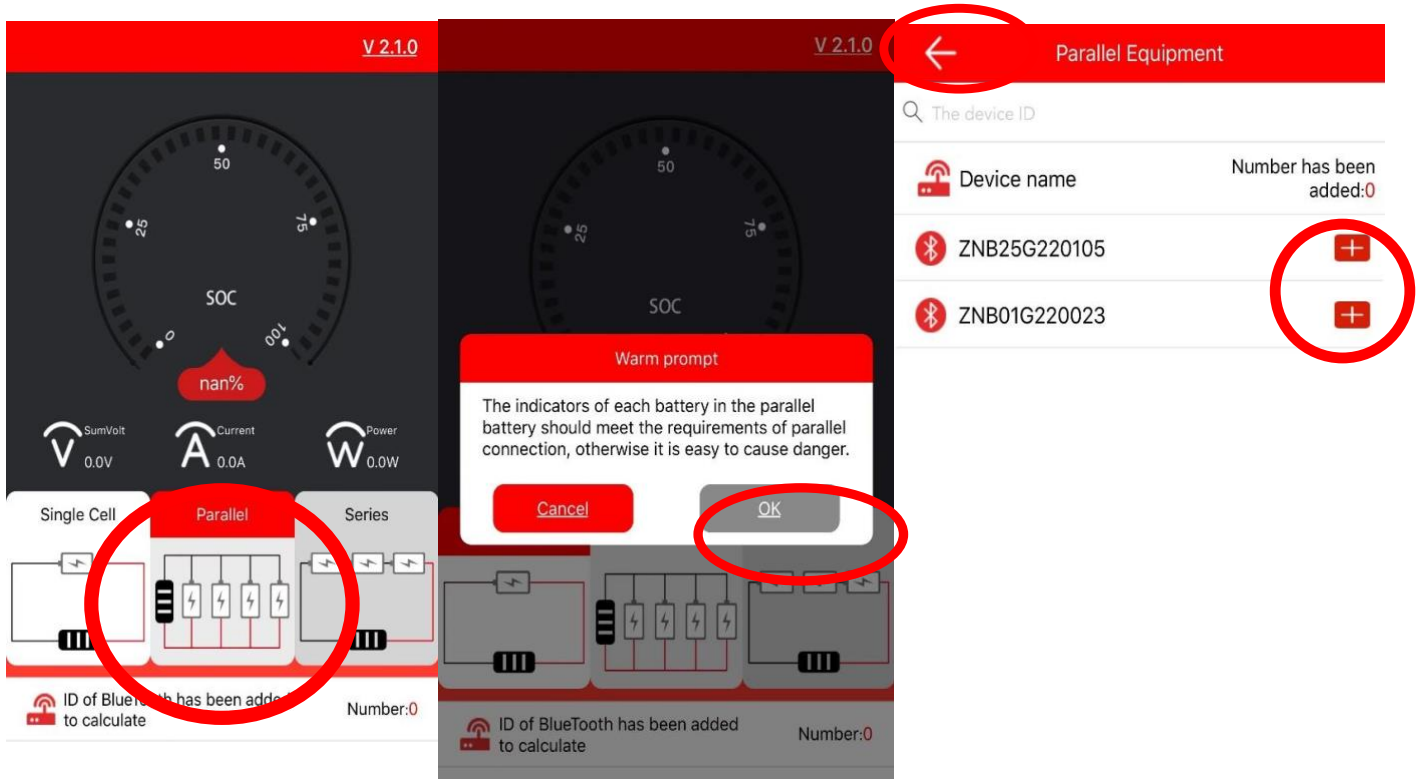

Show the main state information of the battery pack after parallel.

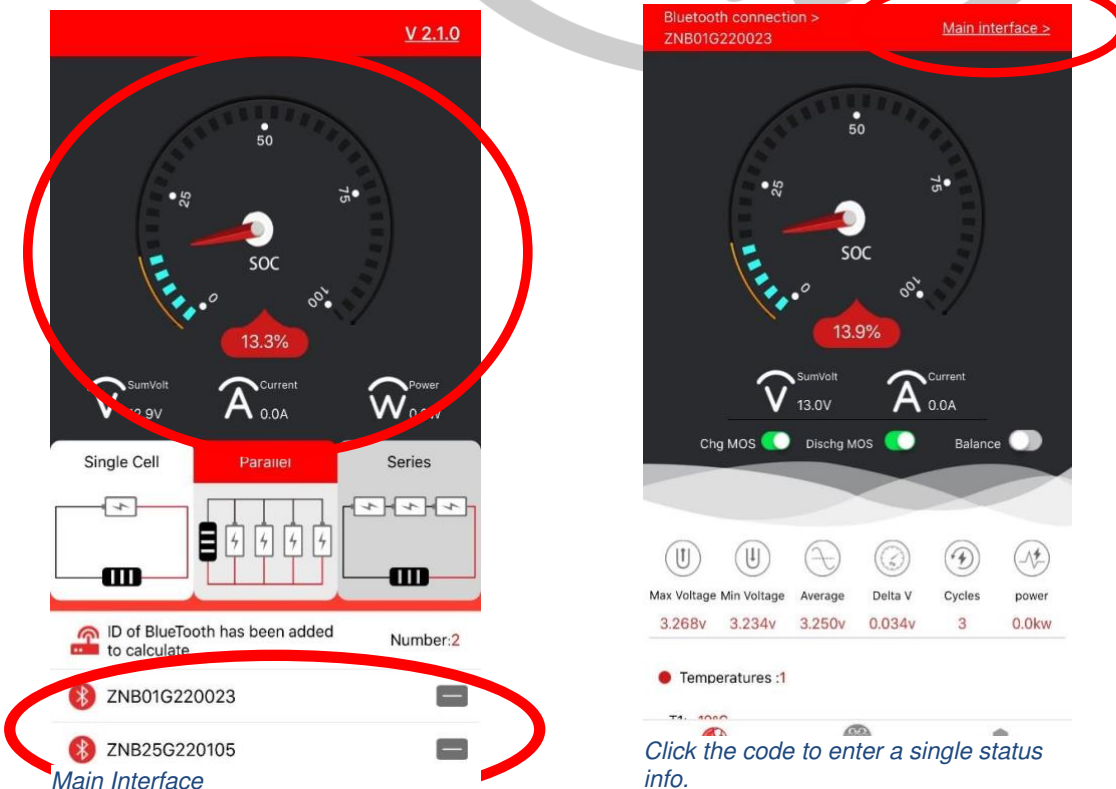

3. Series

- Select the number of the correct battery, be sure to confirm the battery is connected in the series and working normally.
- Red '+' representative is to be selected, and the grey '-' represents the selection. Choose up to 2, only supports 2 batteries in the series.
- After selecting, click the arrow in the supper left corner to enter the main interface.

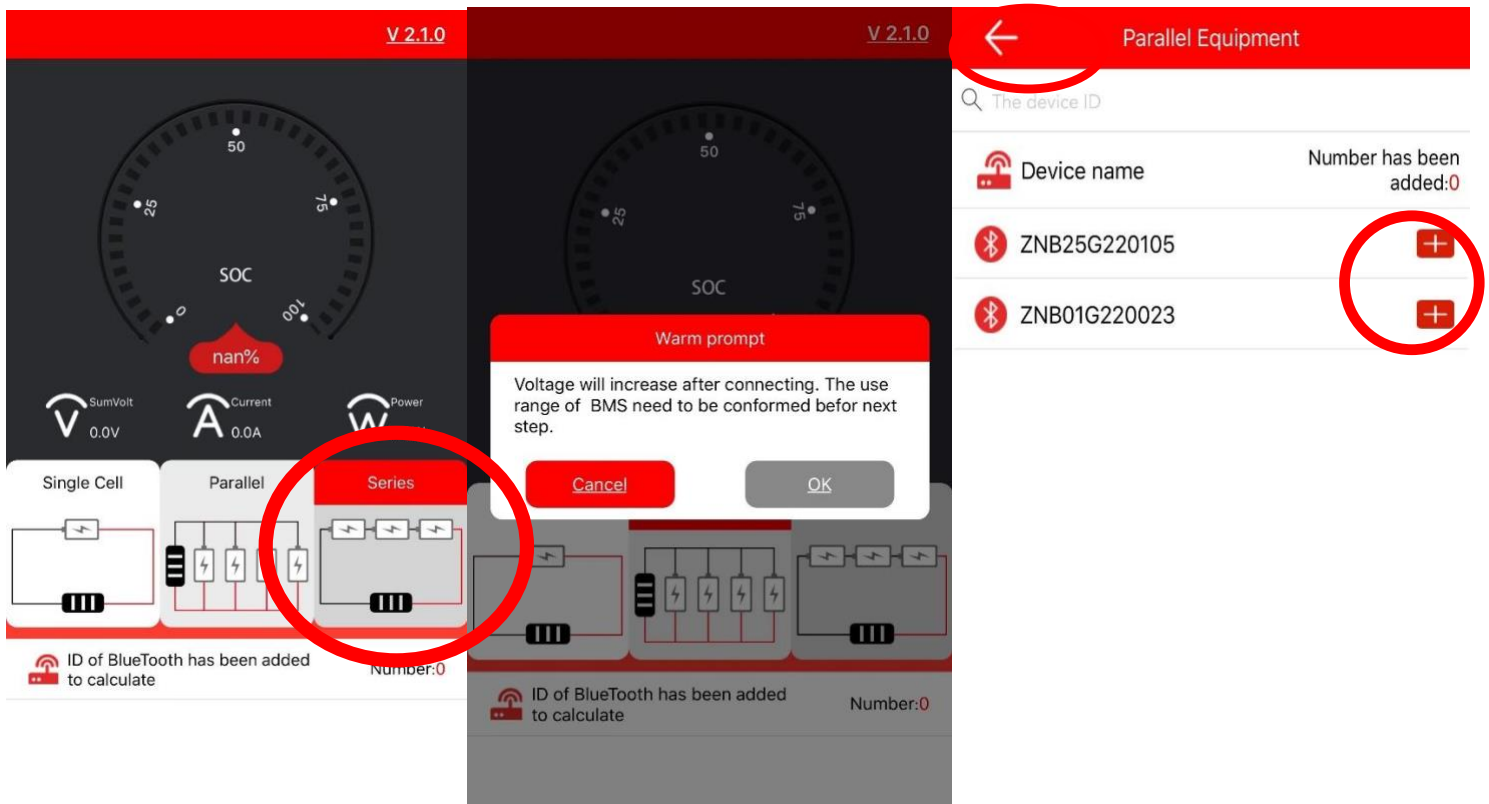

Show the main information of the battery pack after series.

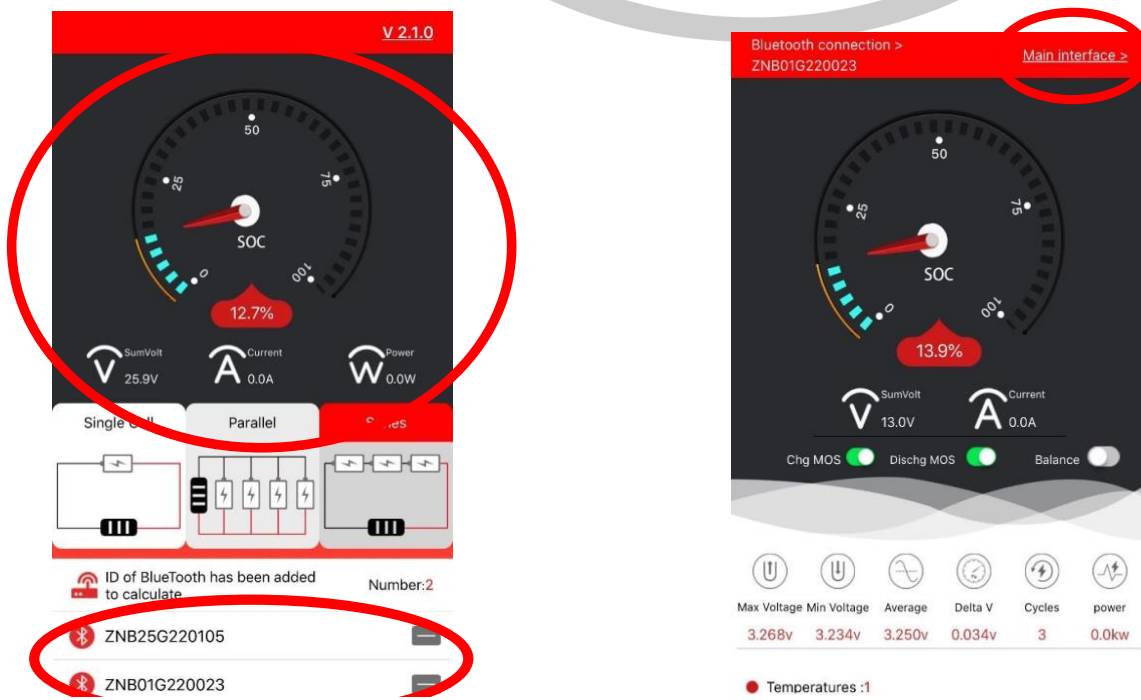

Show the main state information of the battery pack after series. Also shows the selected battery codes.

Temperatures :1
Click the code to enter a single status info.

Solar Panel

Your camper is supplied with 2 x 150W Solar panels mounted on the roof. It is wired to the DC Charger on the camper which regulates the current from the panels into the Batteries. The Solar panel will trickle charge the battery when in full sun. Constant checking of the solar panel is required and monitoring of the Battery Voltage when using appliance such as your Fridge or 12V Lights.

12 Volt Wiring Diagram

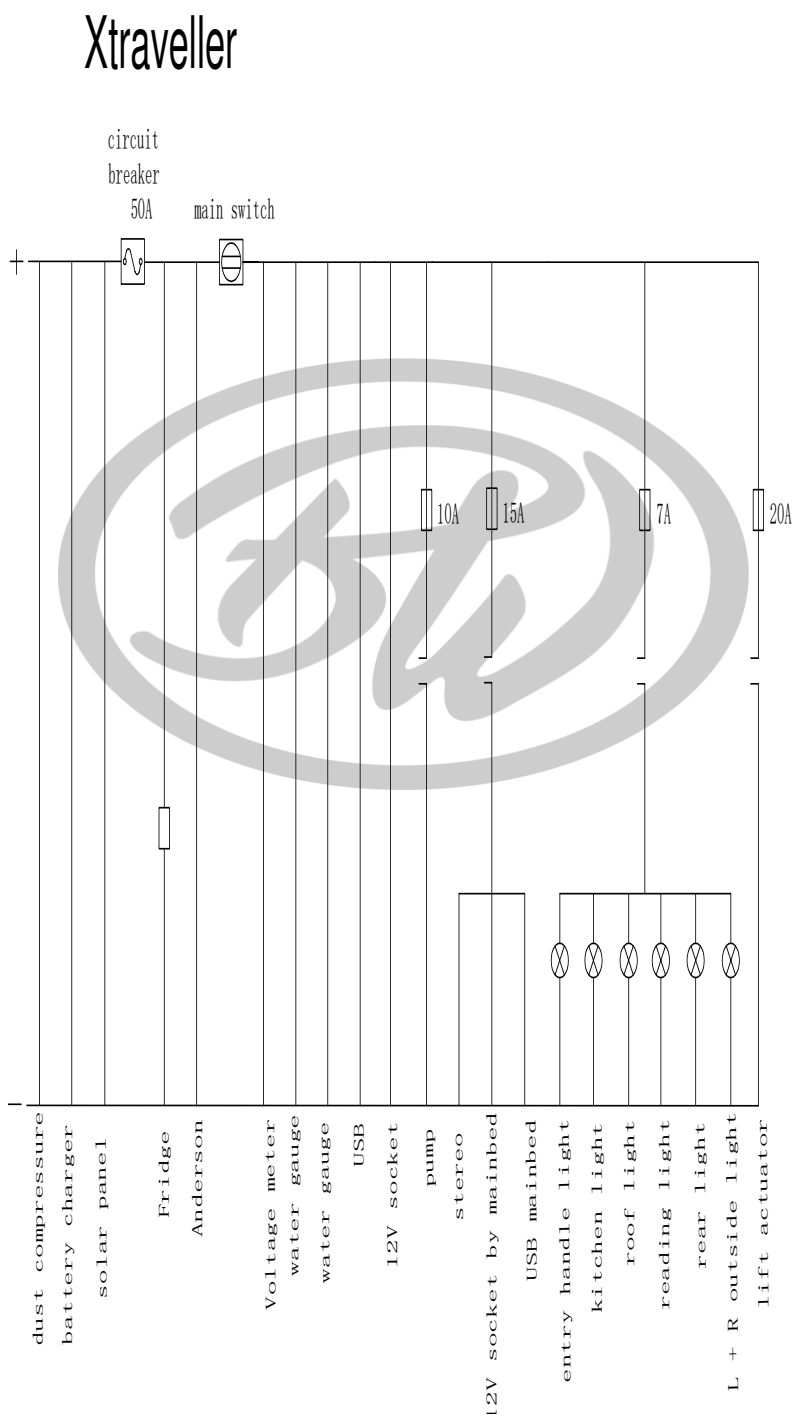

Control Panel

Control panel with functions indicated.

1. LED Volt Meter
2. 12 volt Isolation Master switch
3. 50A Anderson Circuit Breaker Switch
4. Lights Main Switch & Breaker
5. Water Pump Main Switch & Breaker
6. DC Power Main Switch and Breaker
7. Charge Switch and Breaker. This is for the Battery indicator inside the camper

* Volt Meter shows battery voltage while idle and charge voltage whilst charging.

Hot Water System

Your Camper is supplied with a Smarttek Black instant gas Hot Water System, along with all hoses, fittings and Shower accessories required to connect the shower. You also have a T piece to be able to have hot water connected to the kitchen water line at the same time as a Shower Hose. For more information you can visit the Smarttek website.

<https://smarttek.com.au>

Water Pump

The Seaflo water pump, when switched on, is activated by the release of pressure at the taps and will pump water continuously until the tap is turned off and pressure restored. Should the pump activate while one of the taps is turned off this could indicate a leak and require investigation and rectification.

Mains Water

Your camper has a mains water inlet on the drivers side next to the water tank filler cap. You can connect a fresh water hose to this fitting and it will give water pressure from a mains source, direct to the taps. The mains water system bypasses the water tanks, so it does not fill it. It also bypasses the water pump. There is a pressure reducer fitted behind the filler nozzle to bring the pressure back to no more than 350kpa. The water pump switch should be in the off position when connected to mains water.

Connecting the Gas

Your camper is fitted with plumbed gas with the regulator and gas bottle placement at the front of the camper in the storage box. Always ensure gas bottles are serviceable and within the 10 year service life. This information is stamped on the bottle base. Ensure all controls on the stove are in the "Off" position and then turn on the gas bottle valve. Remove the gas hose from the rear of the kitchen and connect using the bayonet fitting to the socket below the pantry drawers. Your kitchen stove is fitted with electric ignition, simply push the relevant burner knob and the ignitor will start working. When the burner ignites hold the button down for 5 seconds then release. **NOTE: It will take up to a minute or so for the gas to purge the line and flow through the burners.**

All gas appliances and supply must be turned off at the isolation valve when towing. Always turn off your gas bottle before towing your caravan. Never use gas appliances without adequate ventilation and always remove any gas flue covers before use. Do not place items near or on any gas flue or exhaust as this may result in a fire or malfunction causing serious injury or death. Always keep a minimum of 500mm clearance from all flue's and exhausts.

Kitchen

To Open the kitchen side hatch simply press the 2 locks on the side and drop down the door. Depress the tabs on the slides at the same time, and the kitchen will slide out.. The water plumbing is connected automatically, no need to connect any hoses. Connect the gas hose to the bayonet, turn the gas bottle on and allow at least a minute for the gas to flow through to the burners, before trying to use the stove. The waste water drains below the kitchen and needs to be caught in a bucket or ran away with a sullage hose.

Pre-Trip Checklist

Working from a checklist will help avoid forgetting important tasks particularly with regard to safety. Individual camper set ups may differ depending on tow vehicle and any modifications made by the owner. The table below is for guidance only.

Pre Hook Up	
Water Tank full & locking cap secure	All latches and door locks secure
Bearings checked and serviced at last service	All cables and plugs are in serviceable condition
Hitch greased and checked	Tyres in serviceable condition and correct pressure
Wheel nuts tight and torqued to correct tension	Bearing caps secure
All external fittings secure	Stabilizer legs working & secure in travel position
Gas bottles and jerry cans secured	Stabilizer leg handle in trailer
Chains and shackles in serviceable condition	
Hooked Up To Vehicle	
Hitch secured to receiver all pins and locks engaged	Trailer lights plugged in
Anderson plug connected	All cables clear of possible damage
Safety chains and shackles connected to car	Chains are crossed and at correct length
All lights working	Trailer brakes engaging when brakes applied
Awning is in and secured with locks	Trailer is sitting at correct level
Jockey wheel is raised and locked	Do a walk around and check visually
Gas Bottles are turned off	Lid is Lowered and secured with Latches

Useful Accessories

Levelling Blocks

These are excellent for levelling your trailer on set up. Stabilizer legs are not meant for correcting the trailer angle, they are there to keep it stable when people are in it. Using levelling blocks will extend the service life of the stabilizer legs and make set up much safer and faster. See below images.



Wheel Chocks

Wheel chocks are an important safety device when leaving your trailer parked on even the slightest incline. On level ground it is recommended to chock both sides of the wheel. On a hill you should chock the wheels on the downhill side ensuring the chocks



Covers

Hard floor campers and caravans will benefit greatly from an EMU CAMPERS storage cover. Perishable fittings such as rubber seals and plastic will be protected from UV radiation and harsh outdoor weather. Paint and gelcoat finishes will oxidize less and this will extend the service life of these finishes.

Stone Protection

There are proprietary devices available that assist in protecting your trailer from stones thrown up by the tow vehicle. Rock Tamer and Stone Stomper are two of the most commonly used.



Problem	Possible Cause	Remedy
No 12 volt power	Main Isolator in off Position	Turn on main isolator
	Flat battery	Charge battery
	Faulty battery	Replace
	Main circuit breaker tripped	Reset main circuit breaker
	Loose battery terminals	Tighten terminals
Battery not Charging	Damaged wiring	Find and repair/replace
	Faulty Battery	Have battery tested and replace if faulty
	No mains power	Indicated by charger not turned on. Check mains power, if charger still doesn't switch on the charger may be faulty and you should contact the dealer for warranty or replacement
	Faulty Charger	A charger fault will be indicated by fast flashing on the charger control panel (Projecta Intelli-Charge). Contact your dealer for warranty or replacement.
	Charger has overheated	Indicated by OTP on LCD screen and fast flashing. Ensure adequate ventilation around charger and allow to cool. Do not store items around the electronics. (Projecta Intelli-Charge)
Lights or plugs not working	Tripped circuit breaker	Reset breaker
	Poor connection	find and rectify
No power to fridge	Circuit switch off	Check control panel and switch on
Indicators or parking lights not working	Poor connection at trailer plug	Check and clean plug contacts. If pins are closed up use a knife to separate the split in the pins being sure not to widen too far. The gap should be even along the length of the pin.
	Poor connection	Check 12v connections are tight
Inverter not powering	Main 12v switch is off	Check main rotary switch on control panel
	Flat battery	Charge battery
	200A main circuit breaker	If no other 12v is available check the main 200A breaker with a multimeter or test light
No Inverter Output	150A breaker to Inverter	check 150A breaker to inverter using a multimeter or test light
	See Inverter trouble shooting page	
Circuit breaker tripping during use	Overloading	Check amperage draw from appliance
	Faulty Appliance	Check appliance and rectify
Battery not charging from anderson plug	Faulty Connection at plug	Check plug ensuring connections are firm
	50A circuit breaker tripping	Check there are no shorts and check circuit breaker with multimeter or test light
	BMS	Check BMS is correctly set and operating (see manual page)

Trouble Shooting

Electrical

Water

Problem	Possible Cause	Remedy
Pump not working (no noise)	No power from control panel	Check circuit breaker
	Flat Battery	Charge battery
	Faulty pressure switch	Replace pump, Contact dealer for replacement
	Bad electrical connection	Check connections with multimeter or test light
Pump working but no water flow	Airlock in water lines	Turn on tap and hold finger over nozzle for 5 seconds and release. Repeat several times. If this fails, fill water tank and use mains pressure to pressurize tank
	Water tank is empty	Fill water tank
	Kinked hose	Check hoses ensuring none are fouled
	Damaged / worn pump diaphragm	Repair or replace pump

Gas

Problem	Possible Cause	Remedy
Cooker not igniting	Gas bottle empty	Fill gas bottle
	Gas bottle not turned on	Turn on valve on gas bottle
	Regulator blocked	Check regulator is not blocked with dirt, wasps nests etc

Brakes

Problem	Possible Cause	Remedy
No Brakes	Open Circuits	Find and correct
	Severe under adjustments	Adjust brakes
	Faulty controller	Test and correct/replace
	Short circuits	Find and correct
Weak Brakes	Great or oil on linings or magnets	Clean or replace
	Corroded connection	Clean or replace connectors
	Worn lining or magnets	Replace
	Scored or grooved brake drums	Machine or replace
	Poor Synchronization	Correct Controller setting
	Poor Brake adjustment	Adjust Brakes
	Glazed brake Linings	Re-burnish or replace linings
	Overloaded trailer	Correct loading. Check at weighbridge
Brakes Locking	Poor Synchronizing with controller	Adjust controller
	Poor Adjustment	Adjust brakes as per instructions
	Faulty controller	Test and rectify or replace
	Loose, bent or broken components	Inspect and replace components
	Out-of-round brake drums	Machine or replace
	Insufficient wheel load (dual Axle)	Correct trailer level to even load
Intermittent brakes	Faulty controller	Test and Correct
	Broken Wires	Repair or replace
	Loose connections	Find and repair
	Faulty ground	Find and repair

Handy Tips

Driving Off Road

Towing your camper off road adds many dimensions to the driver's responsibilities and factors to be considered. When travelling remote always carry sufficient spare parts and supplies to cater for a "worst case scenario."

Always perform suggested preventative maintenance and daily checks. Minimum trailer spares would consist of:

- Wheel Bearings
- Seals
- Wheel studs and nuts

These are available from Eagle Outdoors

When driving rough and corrugated road, it is best practice to take regular breaks. Constant and prolonged period on corrugations and rough tracks without a break are the prime cause of shock absorber and suspension bush failure. These items can become hot when subjected to long periods of hard work. On corrugated roads you should take regular breaks to allow the working parts to cool. Bushes are made from a thermoplastic and will soften and deteriorate quickly when abused. The same applies to shock absorber.

Wildlife

Australian outback roads are notorious for wandering stock and native wildlife which can be a serious danger to motorists. Due care must always be taken, and the possibility of an animal strike considered in regard to speed and time of day you are driving. Most animals in the outback are more active at night which greatly increases the likelihood of an animal strike between dusk and dawn. Towing a camper or caravan increases braking distance and has inherent risk associated with aggressive and defensive maneuvering to avoid a collision.

Corrugations & rough road

Corrugations are arguably the most taxing and damaging road conditions to vehicles. Constant vibration can loosen vehicle components and as a stress dynamic to vehicles and drivers well in excess of normal road driving. In these conditions take regular breaks to reduce driver fatigue and fatigue to vehicles. Shock absorbers can become extremely hot on corrugated roads which can cause damage to seals resulting in shock absorber fade (reduction in damping effect) and in extreme cases failure of the seal completely. On rough and corrugated roads, it's important to adjust tyre pressures on your car and trailer to soften the effect and extend the contact patch of the tyre on the road.

Bulldust

This phenomenon is common on outback roads. Fine dust can settle in large holes obscuring them from unsuspecting drivers. It is important to reduce speed in these conditions and drive carefully to avoid the possibility of damage or an accident.

Sand

When driving on sand it is important to lower tyre pressures on both the vehicle and trailer. By lowering the pressure you will effectively create a larger footprint for the tyre which will reduce how far it sinks in sand. Sand shape and compaction will vary around the country so necessary reduction in tyre pressure will vary. Always keep in mind the lower the pressure the lower the speed you should travel. When lowering pressures to 20psi or less you also increase the chance of rolling the bead of the tyre off the rim so sharp turns should be avoided. When driving these conditions, it is strongly advised you carry a tyre pressure gauge/deflator and a portable compressor to reinflate when back on the highway.

Causeways

Outback roads often have causeways to control water runoff and prevent erosion of the road. When travelling at speed these causeways can be a danger to motorists and vehicles so due care should be taken to reduce speed when approaching them. In very remote areas these often won't have signposts so special care should be taken in these areas.

Creek and River Crossings

These crossings can be extremely dangerous even in low water levels and should never be attempted in times of even mild flooding. Towing a camper or caravan greatly elevates the risk in this situation and should never be attempted unless you are completely assured it is safe to do so. If there is any doubt about access in flood prone areas, you should contact the local authorities to find out conditions and dangers before you proceed.

Protecting the environment

Remote areas and National Parks are sensitive areas and all precautions should be taken not to damage tracks, interfere with flora and fauna and not to contaminate the area. In sensitive areas it is advisable to use grey water tanks and contained toilets. If your camper or caravan isn't fitted with such, both toilets and grey water tanks are available as portable self-contained units. Always store food, food scraps and rubbish in secure containers, native animals can be quite resourceful in scavenging for scraps. Dingos have been known to open locked eskies to get to food so don't chance it, always secure these items when travelling.

Trip Planning

When planning remote trips always consider where you will resupply for fuel, food and water. Some remote fuel stations may run out of fuel during busy periods or times when large fuel trucks are unable to access the area due to road conditions and closures or simply close outside of the season. Always check conditions and availability of fuel before setting out to remote areas.

Shire Councils

There are many resources available for planning your trip away. Every state has a tourism website as so regional councils which will give you extensive information on camping sites, things to do and see, events happening in the area and contact information for booking sites or activities.

National Parks

Each state's national parks organization have a website to assist in finding campsites and provide specific information about each parks unique qualities. As a planning resource these are extremely good. All contact information will be available.

Wikicamps

This smartphone app is an excellent resource for finding all kinds of camping across Australia. If you are looking for free camping you won't find a better resource. There is an app add on that even assists in finding fuel stops with user updates on fuel prices.

Facebook

These days there are numerous Facebook groups dedicated to travelling with campers and caravans and also groups dedicated to travel in specific areas. The area specific groups have many locals as members and are a great way to find out local track closures, conditions and research the area in general.

COVID Safe

Staying safe when camping and caravanning:

- Use of fitted face masks outdoors is required if you are unable to stay further than 1.5 metres away from people you don't live with, such as at public transport stations, outdoor markets, walkways and thoroughfares.
- Distances may not be marked, so make sure you keep at least 1.5 metres between you and the next

Warranty Statement

The following information relates to warranties offered by Eagle Outdoors. Please read all the information carefully, and should you have any questions relating to any aspect of this section, then please contact Eagle Outdoors. By purchasing an item from Eagle Outdoors, you hereby agree to all terms and conditions of warranty as set out herein.

Validity of Claims

- Warranties are only valid to the original purchaser of the item in question and are valid from the original date of purchase only.
- Warranties apply only to items sold as "new" and do not extend to any items sold via auction, or deemed to be "factory seconds", "ex-demonstration" or "damaged" unless specifically stated otherwise by Eagle Outdoors in writing. (Please see further on this page for more information).
- Warranties are not transferable under any circumstances. Similarly, if an item is sold to a third party by the original purchaser, then all warranties become null and void, and the original purchaser shall make no claims or be eligible for any claims on behalf of the new owner.
- Warranties do not apply to products purchased from Eagle Outdoors and then used in hire schemes or as rentals.
- Eagle Outdoors does not cover damage due to unauthorized modifications, misuse, abuse, incorrect assembly, improper and irregular maintenance, or accident or collision.
- Any work performed under an authorized warranty claim approved by Eagle Outdoors must be performed by Eagle Outdoors, or an authorized representative of Eagle Outdoors and only with the express written permission of Eagle Outdoors
- Any affiliates, representatives, associates, agents, suppliers, resellers or similar of Eagle Outdoors shall have no authority to authorize or deny warranty claims on behalf of Eagle Outdoors.

Eagle Outdoors shall not be liable, (in part or whole) for any warranties, either express or implied, made by agents or resellers on behalf of Eagle Outdoors without the knowledge or express written permission of Eagle Outdoors. Such unauthorized claims shall be the responsibility of the agent or reseller only.

Caravans & Camper Trailers

Unless stated otherwise, caravans & trailers only are covered by a 12 month limited manufacturer's warranty from the original date of purchase.

Our goods come with guarantees that cannot be excluded under the Australian Consumer Law.

You are entitled to a replacement or refund for a major failure and for compensation for any other reasonably foreseeable loss or damage.

You are also entitled to have the goods repaired or replaced if the goods fail to be of acceptable quality and the failure does not amount to a major failure.

Items not covered under warranty include:

- Rust
- Wheels and Tyres
- Paint
- Travel Covers and Straps
- General consumables (eg bearings, light bulbs etc)
- Zips and mesh or screens are not covered.

In addition to the EMU warranty, the consumer may also be covered by other rights and remedies of Consumer Law in relation to the goods and or services to which this warranty relates to.

Tents

Tents are guaranteed to be in new merchantable condition at the time of purchase. A limited manufacturer's warranty period of 12 Months applies to EMU Camper Tents, poles and fittings. General wear and tear excepted.

Factory Seconds, Ex-Demonstration and Damaged Goods

From time to time, Eagle Outdoors may offer for sale items deemed to be "factory seconds", "ex-demonstration", or "damaged". Any items sold as "factory seconds", "ex-demonstration" or "damaged" items are sold on an "as is" basis.

There are no warranties, refunds, credits, exchanges or similar associated with such items. In the sale of such items, Eagle Outdoors will attempt to provide all relevant information regarding the item, including faults, defects, or similar, however, there may be instances where minor defects or imperfections have been overlooked. This is PURELY UNINTENTIONAL and in no way alters the nature of the sale.

Due to the nature of such items, i.e being "ex-demonstration", "factory seconds" or "damaged", it is reasonable to expect that some imperfections or flaws may exist even where it is not initially apparent. By purchasing such an item, you agree to this statement in full and accept that there are no warranties implied or expressed.

Goods Bought At Auction

From time to time, Eagle Outdoors, may, at its discretion, offer items for auction, either independently or via a third party. Whilst every effort will be made to provide all relevant information regarding the item on auction, as per Australian law, any and all goods bought at auction subsequently do not carry any statutory warranty. Unless specifically stated in writing, and goods sold at auction by, or on behalf of Eagle Outdoors shall carry no warranty.

Lodging a Claim

All warranty claims MUST BE LODGED through our website using our online Warranty Claim Form.

Contact

If you have any further questions relating to warranties, or are unsure about any aspect of this section, then please contact us.

Phone: 1300 500377



LOCK AND SEAL MAINTENANCE

Regular maintenance on the locks and seals on your camper or caravan is important to keep dust and water ingress to minimum. Making these adjustments is easy if you follow these steps.

Tools: You will need a 10mm spanner

To tighten a lock and get more seal compression:

1. Undo the lock nut(fig1)
2. Screw the bolt counter clockwise to lengthen it (fig 2)
3. Close the door and check the compression (fig 3 & 4)
4. Tighten lock nut

The compression on the seal should be between 30 and 50%, this will ensure there is good surface contact and it will minimize water and dust getting by the seal. Check seals on doors make good contact around the entire edge of the doors and haven't worked their way out of the corners leaving a gap.

When you're satisfied the seals are making good contact wipe them down with a rubber protectant to keep them soft and pliable. (fig 5)

Any rubbers that are torn or perished should be replaced.

HOW TO PREVENT MOISTURE IN CAMPERS

There are many ways moisture can appear in campers and caravans with condensation being the most common. Condensation happens when moisture laden air cools and condenses into water. This can be because of something as simple as packing your camper up on a warm humid day or condensation forming because of a dew point under your camper mattress.

We can't prevent this, but we can implement ways to control it with the most effective being moisture absorbing products. These canisters and sachets do a fantastic job of removing moisture, so it doesn't form on textile surfaces like canvas.



Simply place a sachet or two under your mattress and a couple of canisters in the camper or caravan and they will absorb much of the moisture in the air. Between using these and ensuring good seal compression on your camper and not allowing any canvas to protrude through the seals, it will give you the best possible prevention against mold.

Moisture absorbers can be purchased from hardware stores and most supermarkets and are cheap insurance against mold and mildew.

HOW TO SERVICE THE STABILISER LEGS

Servicing the stabilizer legs on your camper or caravan is a very simple task and should be done twice a year.

Step 1 – Remove the dust cover to expose the bevel gears

Step 2 – If they are older and well used it's advisable to degrease the gears to remove any metal or other grit build up.

Step 3 – Apply a generous coating of grease to the gears being sure to work it into the grooves of the teeth.

Step 4 – Replace dust cover.

It's important to remember that telescopic stabilizer are purely for keeping your camper steady. You should never use them to raise the caravan or camper off the ground as the roll pins that fasten the gears on the shafts could break. Never use a rattle gun to raise or lower them, the impact style of driving will damage the gears and pins very quickly. A cordless drill may be used but it's important to use once with a clutch setting that can be set to not over power the gears.

When setting the legs at an angle you should be careful not to overload them which can lead to bending the locating pins on the release handle

USING A CORDLESS DRILL FOR STABILISING THE CAMPER

Winding stabilizer legs up and down can be a time-consuming job and not a fun one on a hit day. To make the job faster and easier why not use a cordless drill?

When doing this it is advisable to use a cordless drill with an adjustable clutch for two reasons:

1. It will prevent you over tightening the stabilizer and damaging the gears or breaking the shear pins inside.
2. A clutch will make it safer as the drill will be less likely to spin in your hands when the stabilizer hits the ground



To transform your drill, you will need an adapter to 3/8 or 1/2" drive depending on your socket, you'll also need a 19mm socket to attach to the stabilizer drive.

Always remember not to over tighten stabilizers to avoid damage to the gears or roll pins.

For caravans that have a more recessed stabilizer you may need a further socket extension to reach the hex drive on the stabilizer as caravans being wider extend beyond the chassis mount for the legs.



Supplier Contact Details

Dometic https://www.dometic.com/en-au/au/contact-us	Thetford Australia Address: 41 Lara Way, Campbellfield VIC 3061 Phone: (03) 9358 0700 Email: infoaus@thetford.com.au
Cruisemaster Address: 352B Bilsen Road, Geebung QLD 4034 Phone: (07) 3624 3800 Email: sales@cruisemaster.com.au	Leisure-Tec Australia Pty Ltd (Truma Hot Water) 50 Metrolink Circuit Campbellfield VIC 3061 Phone: 1300 072018
Statewide Bearings	
Coopers Plains Address: 902 Beaudesert Rd Coopers Plains QLD 4108 Phone: (07) 3717 4444 Email: coopersplains@statewidebearings.com.au	Cairns Unit3, 49 Cook St Cairns QLD 4870 Phone: (07) 4035 1800 Email: cairns@statewidebearings.com.au
Virginia Unit 2, 90 Pritchard Rd Virginia QLD 4014 Phone: (07) 3265 2666 Email: virginia@statewidebearings.com.au	Mackay 59 Central Park Drive, Paget QLD 4740 Ph: (07) 4952 6660 Email: mackay@statewidebearings.com.au
Rockhampton 67 Denham Street Rockhampton, QLD 4700 Ph: (07) 4927 2677 Email: rockhampton@statewidebearings.com.au	Townsville Unit 2, 502 Woolcock Street, Garbutt QLD 4814 Ph: (07) 4758 8855 Email: townsville@statewidebearings.com.au
Beresfield 11 Yilen Close, Beresfield NSW 2322 Ph: (02) 4041 6444 Email: beresfield@statewidebearings.com.au	Smithfield Unit 4, 8 Cooper Street Smithfield, NSW 2164 Ph: 02 9616 0000 Email: smithfield@statewidebearings.com.au
Wollongong Unit 4, 222 Berkeley Road, Unanderra NSW 2526 Ph: (02) 4272 2377 Email: wollongong@statewidebearings.com.au	Kewdale 67 Kewdale Road, Kewdale WA 6105 Ph: (08) 9352 2200 Email: kewdale@statewidebearings.com.au
Albany 80 Chester Pass Road, Albany WA 6330 Ph: (08) 9842 2488 Email: albany@statewidebearings.com.au	Bibra Lake Unit 6, 30 Salpietro Street, Bibra Lake WA 6163 Ph: (08) 9434 9555 Email: bibralake@statewidebearings.com.au
Belmont 5 Hargreaves Street, Belmont WA 6104 Ph: (08) 9478 2444 Email: belmont@statewidebearings.com.au	Bunbury 42 McCombe Road, Davenport, WA 6230 Ph: (08) 9724 9100 Email: bunbury@statewidebearings.com.au

<p>Collie 96 Forrest Street, Collie WA 6225 Ph: (08) 9734 1624 Email: collie@statewidebearings.com.au</p>	<p>Geraldton Unit 1, 75 Flores Road, Geraldton WA 6530 Ph: (08) 9964 4655 Email: geraldton@statewidebearings.com.au</p>
<p>Karratha 51 Orkney Road, Karratha WA 6714 Ph: (08) 9144 2333 Email: karratha@statewidebearings.com.au</p>	<p>Kalgoorlie 5 Darcy Lane, Kalgoorlie WA 6430 Ph: (08) 9091 4111 Email: kalgoorlie@statewidebearings.com.au</p>
<p>Wangara 70 Distinction Road, Wangara, WA 6065 Ph: (08) 9303 6900 Email: wangara@statewidebearings.com.au</p>	<p>Wingfield Grand Jct Rd & South Rd Wingfield SA 5013 Ph: (08) 8260 6299 Email: wingfield@statewidebearings.com.au</p>
<p>Dandenong South 84 Greens Road, Dandenong South VIC 3175 Ph: (03) 8710 9777 Email: dandenong@statewidebearings.com.au</p>	<p>Somerton 15-17 Somerton Road, Somerton VIC 3061 Ph: (03) 9308 0055 Email: somerton@statewidebearings.com.au</p>
<p>Traralgon Unit 7, 4-14 Rocla Road, Traralgon VIC, 3844 Ph: (03) 5172 3000 Email: traralgon@statewidebearings.com.au</p>	<p>Hobart 39 Sunderland Street, Derwent Park TAS 7009 Ph: (03) 6216 6999 Email: Hobart@statewidebearings.com.au</p>

